

PEDESTAL

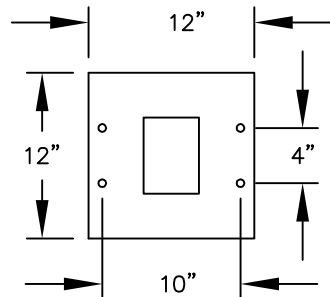

PEDESTAL BASE
BOLT PATTERN

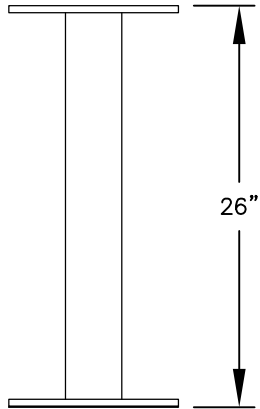
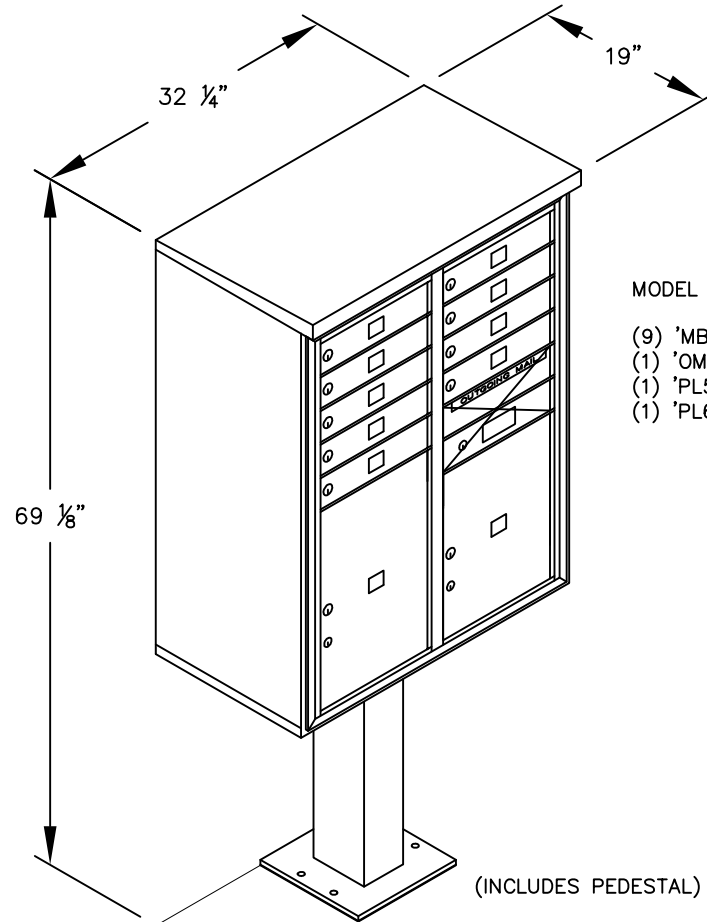

MODEL #3411D-09

- (9) 'MB1' DOORS
- (1) 'OM2' OUTGOING MAIL COMPARTMENT
- (1) 'PL5' PARCEL LOCKER
- (1) 'PL6' PARCEL LOCKER

MODEL #3411D-09

4C PEDESTAL MAILBOX

AVAILABLE COLORS:
SANDSTONE, BRONZE, GREEN,
BLACK, WHITE OR GRAY

DRAWN: 01/13

Established in 1936, Salsbury Industries is the industry leader in manufacturing and distributing quality mailboxes.

1010 E. 62ND STREET
LOS ANGELES, CA 90001
PHONE: (800) 624-5269
FAX: (800) 624-5299
email: engineering@mailboxes.com