

# Pedestal Drop Boxes

## PEDESTAL DROP BOXES PRIVATE access

Made entirely of aluminum, Salsbury 4200 series pedestal drop boxes are available in three (3) different sizes. Model #4275 is 15-3/4" wide, model #4276 is 23" wide and model #4277 is 30-1/4" wide. All pedestal drop boxes include a 28-1/2" high matching pedestal and are the same height (55-1/2") and depth (19"). Standard units are accessed from the rear through a two (2) point latching master door on the #4275 and two (2) master doors on the #4276 and #4277. Each door swings open over 90 degrees for unloading convenience. Standard units include a locking "T" handle (#4290) on the rear door(s), a weather protection hood and a mail flap on the front of the unit. The pedestal drop boxes feature a durable powder coated finish available in three (3) contemporary colors (or primer). Custom options (#4280) and custom colors (#4205) are available upon request.

**Volume Discount Pricing Available at Mailboxes.com!**



#4275's with optional custom engraved placards (#4267) displayed

### CUSTOM PEDESTAL DROP BOX OPTIONS #4280

Pedestal drop boxes can be customized to meet your specific needs. The following options for pedestal drop boxes #4275, #4276 and #4277 are available upon request. Order #4280 for any one of the following options or specify your exact needs. Pedestal drop boxes are ideal for colleges and schools, military bases and many other applications.

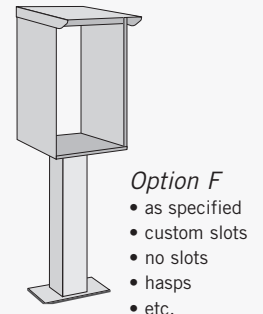
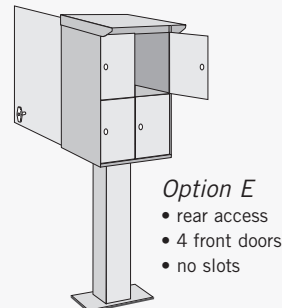
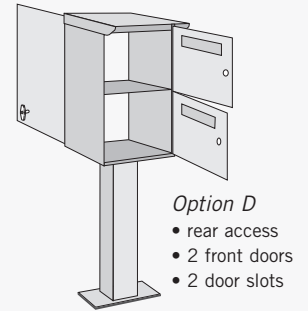
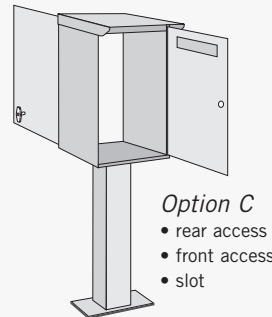
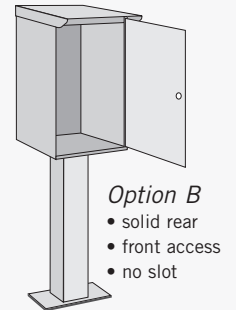
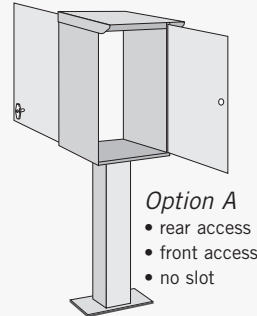

#4275 units with custom options (#4280) displayed

Note: U.S.P.S. front or rear access not available.





Note: Matching pedestals and T-handle locks are included with Pedestal Drop Boxes



**DESCRIPTION**

4275<sup>1</sup> - Pedestal Drop Box - Regular

**UNIT SIZE**

15-3/4" W x 55-1/2" H x 19" D  
 • Mail slot: 12" W x 2" H

**WEIGHT**

55 lbs.

**PRICE**

\$700.00

**DESCRIPTION**

4276<sup>1</sup> - Pedestal Drop Box - Large

**UNIT SIZE**

23" W x 55-1/2" H x 19" D  
 • Mail slot: 18" W x 2" H

**WEIGHT**

65 lbs.

**PRICE**

\$750.00

**DESCRIPTION**

4277<sup>1</sup> - Pedestal Drop Box - Jumbo

**UNIT SIZE**

30-1/4" W x 55-1/2" H x 19" D  
 • Mail slot: 20" W x 2" H

**WEIGHT**

75 lbs.

**PRICE**

\$800.00

**PEDESTAL DROP BOX OPTIONS**

MODEL	DESCRIPTION	UNIT SIZE	WEIGHT	PRICE
4285 <sup>1</sup>	Pedestal - replacement top: 13" W x 11-1/2" D base: 12" W x 6" D	4" W x 28-1/2" H x 5-1/2" D	20 lbs.	\$150.00
4205	Custom color - specify color			add \$125.00
4280	Custom option - for Pedestal Drop Boxes (specify A, B, C, D, E, F)			add \$125.00
4294	Pedestal mounting kit - (4) anchor (J) bolts - for new concrete installations		3 lbs.	\$25.00

**CUSTOM ENGRAVED PLACARDS**

12" W x 2" H custom engraved self-adhesive placards are available as an option upon request. (#4267 - \$15.00)

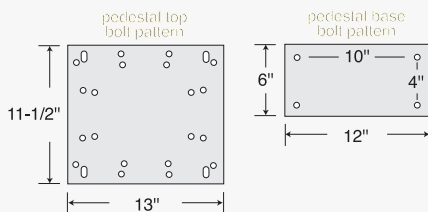

**DEPOSITS**



Replacement T-handle lock (with (2) keys) (#4290 - \$50.00)



Front view of #4276 with open mail flap displayed



Rear view of #4276 with open doors displayed

<sup>1</sup> Specify  gray  white  blue  primer Custom custom color (#4205 - \$125)