



People Committed to Quality Since 1936®

Outdoor Parcel Lockers (OPL's)

eBuy Product Information

OUTDOOR PARCEL LOCKERS FRONT LOADING

Made of heavy duty aluminum and stainless steel hardware, Salsbury U.S.P.S. approved Outdoor Parcel Lockers (OPL's) are accessed from the front through one or two (2) easy opening master doors. The durable and corrosion resistant units feature a powder coated finish available in six (6) contemporary colors. Each OPL includes two or four fully integrated parcel lockers and a matching pedestal with four (4) McGard nuts. Each pre-numbered aluminum door includes a heavy duty five (5) pin cylinder cam lock with a dust/rain shield and three (3) keys. An attractive option for new and existing OPL installations are Salsbury U.S.P.S. approved Regency Decorative accessories (available on 1116T2 unit only).



Includes four (4) McGard nuts

REGENCY® DECORATIVE CBU & OPL ACCESSORIES

Made of die cast aluminum, Salsbury U.S.P.S. approved Regency Decorative CBU and OPL accessories can be ordered separately from Salsbury CBU's and OPL's. Decorative accessories feature a durable powder coated finish available in five (5) contemporary colors and provide an elegant finished look to CBU and OPL installations. Decorative tops (#PS-3350) include a 3" diameter ball finial and an attractive sloping design and easily mount to the top of CBU's and OPL's (Type 2) with four (4) set screws (provided). Decorative pedestal covers (short - #PS-3386 and tall - #PS-3396) easily attach over CBU and OPL pedestals and include a plastic insect guard and installation hardware.



TYPE I OUTDOOR PARCEL LOCKERS (OPL'S)

eBuy MODEL #	COLOR	# of PARCEL LOCKERS	WEIGHT
Unit size: 16" W x 62" H x 18" D (with McGard nuts)			
1116T1	Gray	(2) Parcel Lockers	90 lbs.
1116T1-SAN	Sandstone	(2) Parcel Lockers	90 lbs.
1116T1-BLK	Black	(2) Parcel Lockers	90 lbs.
1116T1-BRZ	Bronze	(2) Parcel Lockers	90 lbs.
1116T1-GRN	Green	(2) Parcel Lockers	90 lbs.
1116T1-WHT	White	(2) Parcel Lockers	90 lbs.



1116T1

TYPE II OUTDOOR PARCEL LOCKERS (OPL'S)

eBuy MODEL #	COLOR	# of PARCEL LOCKERS	WEIGHT
Unit size: 30-1/2" W x 62" H x 18" D (with McGard nuts)			
1116T2	Gray	(4) Parcel Lockers	175 lbs.
1116T2-SAN	Sandstone	(4) Parcel Lockers	175 lbs.
1116T2-BLK	Black	(4) Parcel Lockers	175 lbs.
1116T2-BRZ	Bronze	(4) Parcel Lockers	175 lbs.
1116T2-GRN	Green	(4) Parcel Lockers	175 lbs.
1116T2-WHT	White	(4) Parcel Lockers	175 lbs.



1116T2

REGENCY® CBU / OPL TOP

eBuy MODEL #	COLOR	WEIGHT
Unit size: 31" W x 11-1/2" H x 18-1/2" D		
PS-3350SAN	Sandstone	20 lbs.
PS-3350BLK	Black	20 lbs.
PS-3350BRZ	Bronze	20 lbs.
PS-3350GRN	Green	20 lbs.
PS-3350WHT	White	20 lbs.



PS-3350BRZ

REGENCY® PEDESTAL COVER - SHORT

eBuy MODEL #	COLOR	WEIGHT
Unit size: 13-3/4" H x 17-3/4" Diameter		
PS-3386SAN	Sandstone	20 lbs.
PS-3386BLK	Black	20 lbs.
PS-3386BRZ	Bronze	20 lbs.
PS-3386GRN	Green	20 lbs.
PS-3386WHT	White	20 lbs.



PS-3386SAN

REGENCY® PEDESTAL COVER - TALL

eBuy MODEL #	COLOR	WEIGHT
Unit size: 27-3/4" H x 17-3/4" Diameter		
PS-3396SAN	Sandstone	25 lbs.
PS-3396BLK	Black	25 lbs.
PS-3396BRZ	Bronze	25 lbs.
PS-3396GRN	Green	25 lbs.
PS-3396WHT	White	25 lbs.



PS-3396BLK

eBuy Product Information

UNIVERSAL PEDESTAL

Made entirely of aluminum, Salsbury universal pedestals feature a durable powder coated aluminum finish and can be used as a replacement pedestal for the Neighborhood Delivery and Collection Box Unit (NDCBU) and many other applications.

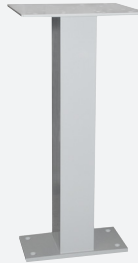

PS-3285

PS-3285 - Universal Pedestal

- 4" W x 28-1/2" H x 5-1/2" D
- top: 13" W x 11-1/2" D
- base: 12" W x 6" D
- 20 lbs.

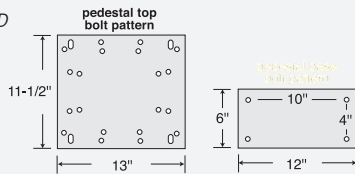

PEDESTALS



PS-3385GRY-M



PS-3395SAN-M

REPLACEMENT PEDESTALS - CBU

eBuy MODEL #	COLOR	MAILBOX TYPE	WEIGHT
Unit size: 12" W x 14-1/2" H x 12" D			(with McGard nuts)
PS-3385GRY-M	Gray	CBU Type 3, 4, 6 / OPL 1,2	15 lbs.
PS-3385SAN-M	Sandstone	CBU Type 3, 4, 6 / OPL 1,2	15 lbs.
PS-3385BLK-M	Black	CBU Type 3, 4, 6 / OPL 1,2	15 lbs.
PS-3385BRZ-M	Bronze	CBU Type 3, 4, 6 / OPL 1,2	15 lbs.
PS-3385GRN-M	Green	CBU Type 3, 4, 6 / OPL 1,2	15 lbs.
PS-3385WHT-M	White	CBU Type 3, 4, 6 / OPL 1,2	15 lbs.
Unit size: 12" W x 28-1/2" H x 12" D			(with McGard nuts)
PS-3395GRY-M	Gray	CBU Type 1, 2, 5	20 lbs.
PS-3395SAN-M	Sandstone	CBU Type 1, 2, 5	20 lbs.
PS-3395BLK-M	Black	CBU Type 1, 2, 5	20 lbs.
PS-3395BRZ-M	Bronze	CBU Type 1, 2, 5	20 lbs.
PS-3395GRN-M	Green	CBU Type 1, 2, 5	20 lbs.
PS-3395WHT-M	White	CBU Type 1, 2, 5	20 lbs.

REPLACEMENT PEDESTALS - HSCBU

eBuy MODEL #	MAILBOX TYPE	WEIGHT
Unit size: 12" W x 14-1/2" H x 12" D		(with McGard nuts)
PS-3385HS-M	HSCBU Type 3, 4	15 lbs.
Unit size: 12" W x 28-1/2" H x 12" D		(with McGard nuts)
PS-3395HS-M	HSCBU Type 1, 2	20 lbs.

REPLACEMENT DOORS

3-1/8" H TENANT DOOR KITS WITHOUT LOCK

eBuy MODEL #	COLOR	WEIGHT
Unit size: 12-3/4" W x 3-1/8" H x 1/4" D		
PS-3351GRY	Gray	1 lb.
PS-3351SAN	Sandstone	1 lb.
PS-3351BLK	Black	1 lb.
PS-3351BRZ	Bronze	1 lb.
PS-3351GRN	Green	1 lb.
PS-3351WHT	White	1 lb.

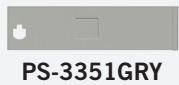

PS-3351GRY

4-7/8" H TENANT DOOR KITS WITHOUT LOCK

eBuy MODEL #	COLOR	WEIGHT
Unit size: 12-3/4" W x 4-7/8" H x 1/4" D		
PS-3352GRY	Gray	1 lb.
PS-3352SAN	Sandstone	1 lb.
PS-3352BLK	Black	1 lb.
PS-3352BRZ	Bronze	1 lb.
PS-3352GRN	Green	1 lb.
PS-3352WHT	White	1 lb.

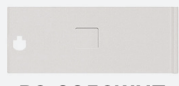

PS-3352WHT

6-5/8" H TENANT DOOR KITS WITHOUT LOCK

eBuy MODEL #	COLOR	WEIGHT
Unit size: 12-3/4" W x 6-5/8" H x 1/4" D		
PS-3356GRY	Gray	2 lbs.
PS-3356SAN	Sandstone	2 lbs.
PS-3356BLK	Black	2 lbs.
PS-3356BRZ	Bronze	2 lbs.
PS-3356GRN	Green	2 lbs.
PS-3356WHT	White	2 lbs.

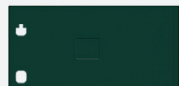

PS-3356GRN

3-1/8" H POSTAL ACCESS DOOR KITS

eBuy MODEL #	COLOR	WEIGHT
Unit size: 12-3/4" W x 3-1/8" H x 1/4" D		
PS-3357GRY	Gray	1 lb.
PS-3357SAN	Sandstone	1 lb.
PS-3357BLK	Black	1 lb.
PS-3357BRZ	Bronze	1 lb.
PS-3357GRN	Green	1 lb.
PS-3357WHT	White	1 lb.



PS-3357GRY

SMALL PARCEL DOOR KITS WITHOUT LOCK

eBuy MODEL #	COLOR	WEIGHT
Unit size: 12-3/4" W x 10-1/4" H x 1/4" D		
PS-3353GRY	Gray	3 lbs.
PS-3353SAN	Sandstone	3 lbs.
PS-3353BLK	Black	3 lbs.
PS-3353BRZ	Bronze	3 lbs.
PS-3353GRN	Green	3 lbs.
PS-3353WHT	White	3 lbs.

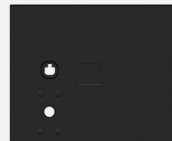

PS-3353BLK

LARGE PARCEL DOOR KITS WITHOUT LOCK

eBuy MODEL #	COLOR	WEIGHT
Unit size: 12-3/4" W x 13-3/4" H x 1/4" D		
PS-3354GRY	Gray	4 lbs.
PS-3354SAN	Sandstone	4 lbs.
PS-3354BLK	Black	4 lbs.
PS-3354BRZ	Bronze	4 lbs.
PS-3354GRN	Green	4 lbs.
PS-3354WHT	White	4 lbs.

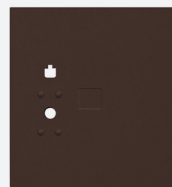

PS-3354BRZ

OPL PARCEL DOOR KITS WITHOUT LOCK

eBuy MODEL #	COLOR	WEIGHT
Unit size: 12-3/4" W x 19-7/8" H x 1/4" D		
PS-3355GRY	Gray	5 lbs.
PS-3355SAN	Sandstone	5 lbs.
PS-3355BLK	Black	5 lbs.
PS-3355BRZ	Bronze	5 lbs.
PS-3355GRN	Green	5 lbs.
PS-3355WHT	White	5 lbs.



PS-3355SAN

4-7/8" H POSTAL ACCESS DOOR KITS

eBuy MODEL #	COLOR	WEIGHT
Unit size: 12-3/4" W x 4-7/8" H x 1/4" D		
PS-3358GRY	Gray	2 lbs.
PS-3358SAN	Sandstone	2 lbs.
PS-3358BLK	Black	2 lbs.
PS-3358BRZ	Bronze	2 lbs.
PS-3358GRN	Green	2 lbs.
PS-3358WHT	White	2 lbs.



PS-3358WHT

eBuy Product Information

KEY KEEPERS

Made of 20 gauge steel, Salsbury key keepers are available as surface mounted or recessed mounted units and feature a durable powder coated aluminum finish. A key keeper allows the U.S.P.S. or other individuals to access a key and deliver the mail and is useful when restricted access to a building or mailroom is required.



PS-1080AU - Key Keeper - surface mounted

- 6" W x 3-1/4" H x 2" D
- 2 lbs.

PS-1090AU - Key Keeper - recessed mounted

- 6" W x 3-1/4" H x 2" D
- rough opening: 5" W x 2-1/2" H x 1-3/4" D
- 2 lbs.

PS-1090C - Key Keeper - recessed mounted

- Custom paint finish (must be specified)
- 6" W x 3-1/4" H x 2" D
- rough opening: 5" W x 2-1/2" H x 1-3/4" D
- 2 lbs.

PLACARDS / DECALS



PS-3367
Custom Door ID Placards
(Silver with Black Print)

- Up to six characters



PS-1056126
Lock Rotation Decal
(for OPL's)

- Clockwise



PS-1055943
Lock Rotation Decal
(for CBU's and HSCBU)

- Clockwise



PS-3337
Lock Rotation Decal
(for Old Style OPL's)

- Counter-clockwise

HARDWARE



PS-1055294
Tamperproof Screw
(for CBU's and OPL's)

- 1-Way 10-32 x .375"
- UNF-2A 18-8 SS



PS-3335
Tamperproof Screw

- 1-Way 8-32 x .250"
- UNF-2A 18-8 SS



PS-3334
Cam (for CBU Mailboxes)



PS-1055944
Allen Head Screw

- 10-32 x .625"

MISCELLANEOUS



PS-330016
Touch-up Paint Pen
(Postal Gray)



PS-330015
Touch-up Spray Paint
(Postal Gray)



PS-3336
Thin Wall Hex
Nut Driver
(for CBU's and OPL's)



PS-86160
Key Holder & Label
(for CBU/OPL
Parcel Lockers)

- Set of 3



PS-3399
Key Blank
(for CompX 910 CBU)

- 1000PS-1999PS or
3000PS-3999PS



PS-3399R
Key Blank
(for CompX 910 CBU)

- 2000PS-2999PS or
4000PS-4999PS

REPLACEMENT PART KITS



PS-3331
Parcel Locker
Spring Hardware Kit



PS-3332
Cam Assembly Kit
(for Parcel Lockers)



PS-86101-F
Unit to Pedestal Bolt Kit
(for CBU's and OPL's)



PS-3333
Parcel Locker Kit
with Hardware (for CBU's)



PS-91011
Arrow Lock Release
Latch Lever Kit



PS-64216-SS
OPL Parcel Locker
Arrow Lock Cover Kit



PS-91040
Long Hinge Rod Kit



PS-91127
Short Hinge Rod Kit



PS-91255A
Parcel Locker
Hardware Only Kit



PS-91255
Parcel Locker
Cover Kit



PS-64213-SS
Cam & Arm Assembly Kit
(for OPL's)



PS-3370
Outgoing Mail Slot "Plug" Kit
(for CBU's)



PS-92300
Arrow Lock
Hardware Kit



PS-91610
Parcel Locker
Lock Assembly Kit



PS-91067
Hold Open Rod Kit

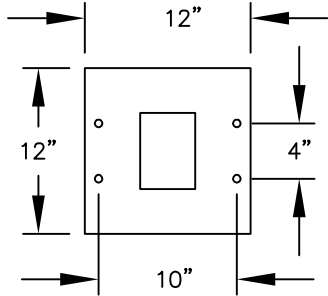
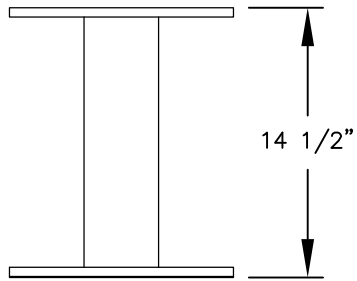

PEDESTAL BASE
BOLT PATTERN

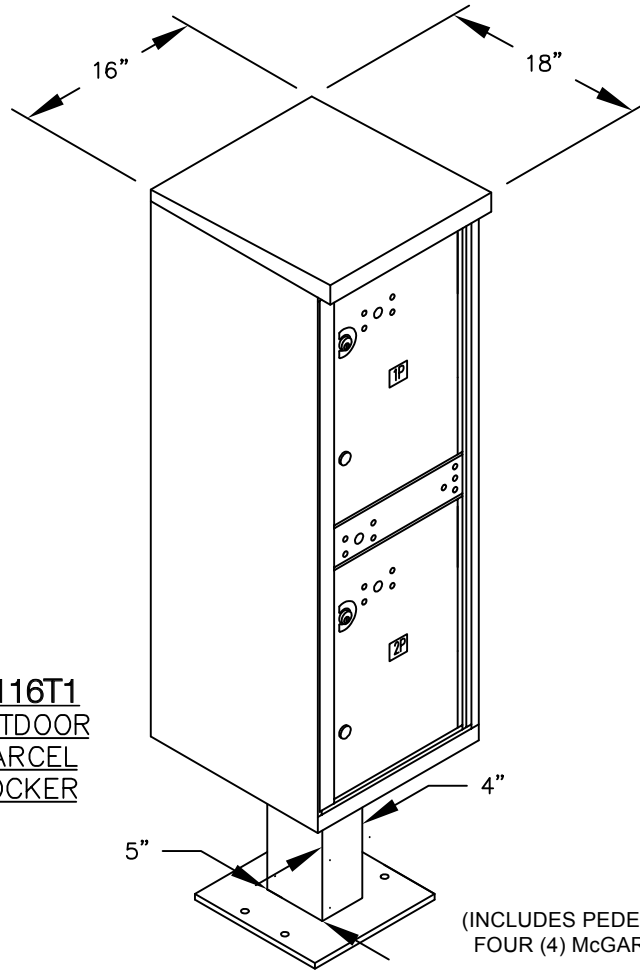

1116T1
OUTDOOR
PARCEL
LOCKER

(INCLUDES PEDESTAL AND
FOUR (4) McGARD NUTS)

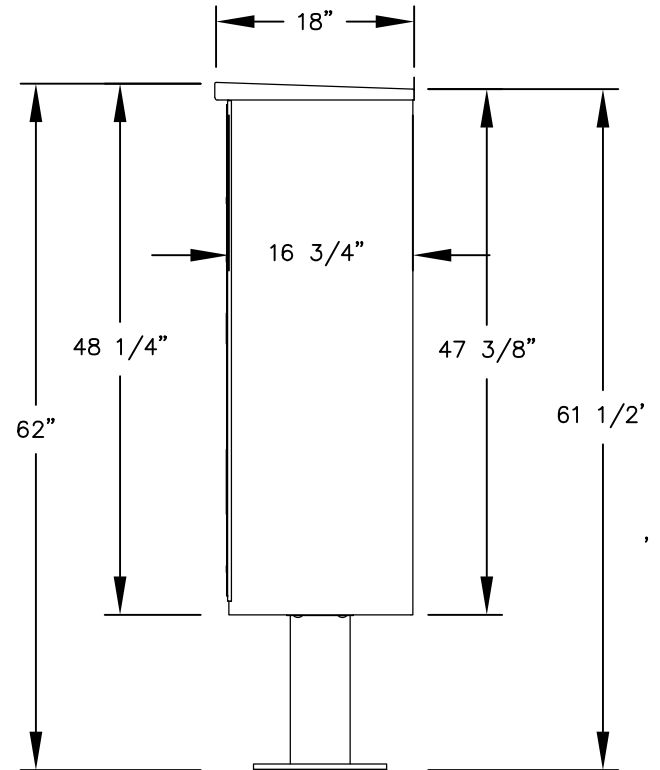

Model #: 1116T1
OUTDOOR PARCEL LOCKER

Contract #: 3DVDIE-18-B-0041

AVAILABLE COLORS:
GRAY, SANDSTONE, BLACK, BRONZE,
GREEN OR WHITE

DRAWN: 01/2020

Established in 1936, Salsbury Industries is the industry leader in manufacturing and distributing quality mailboxes.

18300 CENTRAL AVENUE
CARSON, CA 90746-4008
PHONE: (800) 624-5299
FAX: (800) 624-5299
email: eBuy@mailboxes.com

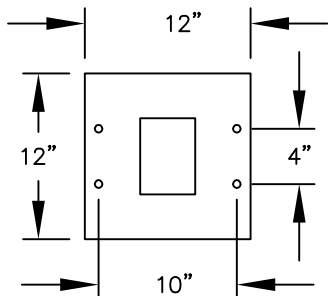
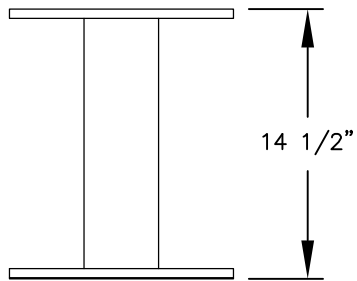

PEDESTAL BASE
BOLT PATTERN

1116T2
OUTDOOR
PARCEL
LOCKER

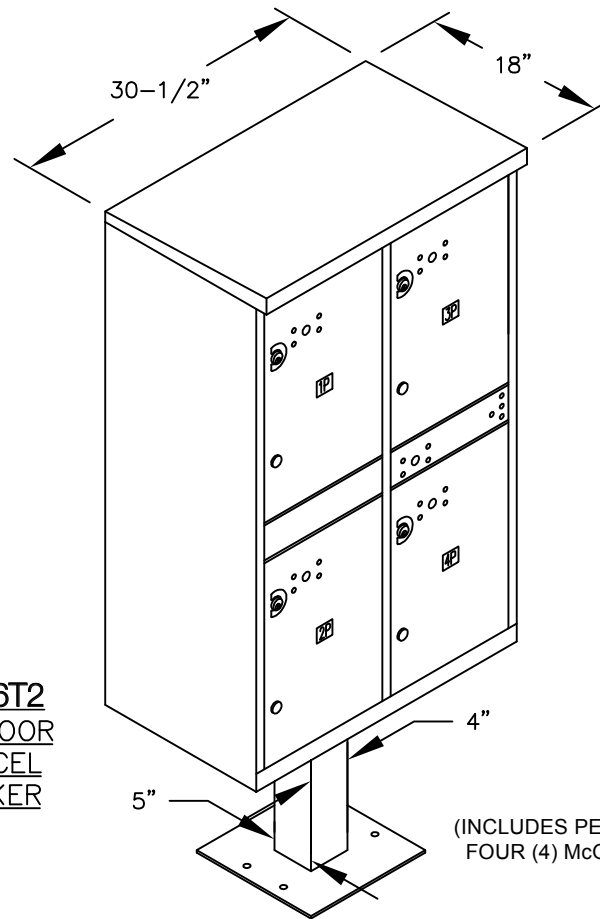

(INCLUDES PEDESTAL AND
FOUR (4) McGARD NUTS)

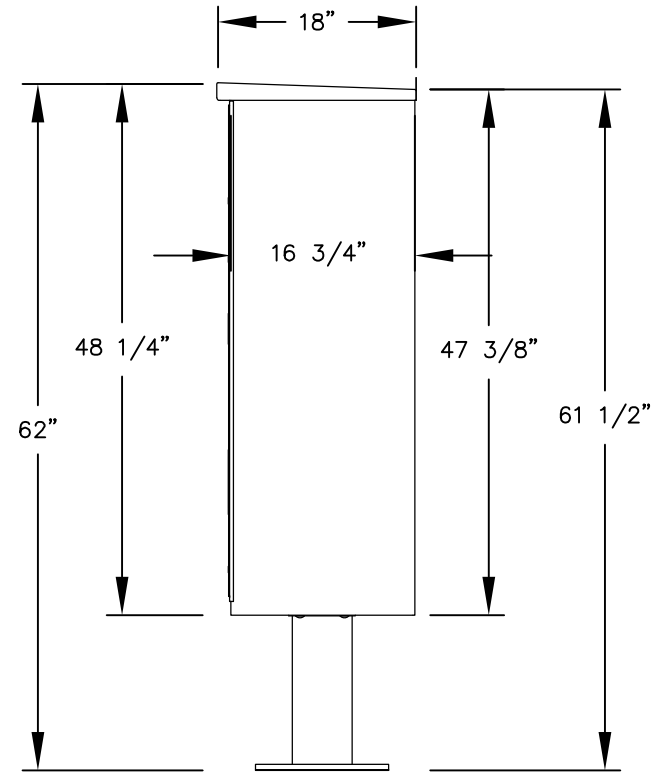

Model #: 1116T2
OUTDOOR PARCEL LOCKER

Contract #: 3DVDIE-18-B-0041

AVAILABLE COLORS:
GRAY, SANDSTONE, BLACK, BRONZE,
GREEN OR WHITE

DRAWN: 01/2020

Established in 1936, Salsbury Industries is the industry leader in manufacturing and distributing quality mailboxes.

18300 CENTRAL AVENUE
CARSON, CA 90746-4008
PHONE: (800) 624-5269
FAX: (800) 624-5299
email: eBuy@mailboxes.com