



People Committed to Quality Since 1936<sup>®</sup>

# Indoor Parcel Lockers (IPL's)

## eBuy Product Information

### STAND-ALONE INDOOR PARCEL LOCKERS DOUBLE COLUMN FRONT LOADING

Made of heavy duty aluminum and stainless steel hardware, Salsbury stand-alone double column front loading indoor parcel lockers (IPL's) are USPS approved. Stand-alone IPL's are available with standard compartments that are 12" wide and 17" deep with heights varying from 10" (PL3) to 20-1/2" (PL6). All parcel doors include a heavy duty cam lock with a dust/rain shield and three (3) keys. Stand-alone IPL's also contain a carrier access door allowing for efficient mail distribution from the front of the unit. Designed for indoor use, stand-alone IPL's feature a durable powder coated aluminum finish.



IPL-SA-8A  
(7125-17-000-6038)



IPL-SA-9A  
(7125-17-000-6039)



IPL-SA-10A  
(7125-17-000-6040)

### STAND-ALONE DOUBLE COLUMN FRONT LOADING IPL'S

eBuy MODEL #	# of INDOOR PARCEL LOCKERS	WEIGHT
Unit size: 32-1/4" W x 73-1/2" H x 21" D		
IPL-SA-8A	8 Parcel Lockers	260 lbs.
IPL-SA-9A	9 Parcel Lockers	265 lbs.
IPL-SA-10A	10 Parcel Lockers	270 lbs.

### STAND-ALONE INDOOR PARCEL LOCKERS SINGLE COLUMN FRONT LOADING

Made of heavy duty aluminum and stainless steel hardware, Salsbury stand-alone single column front loading indoor parcel lockers (IPL's) are USPS approved. Stand-alone IPL's are available with standard compartments that are 12" wide and 17" deep with heights varying from 10" (PL3) to 20-1/2" (PL6). All parcel doors include a heavy duty cam lock with a dust/rain shield and three (3) keys. Stand-alone IPL's also contain a carrier access door allowing for efficient mail distribution from the front of the unit. Designed for indoor use, stand-alone IPL's feature a durable powder coated aluminum finish.



IPL-SA-3A



IPL-SA-4A



IPL-SA-5A

### STAND-ALONE SINGLE COLUMN FRONT LOADING IPL'S

eBuy MODEL #	# of INDOOR PARCEL LOCKERS	WEIGHT
Unit size: 17-1/2" W x 73-1/2" H x 21" D		
IPL-SA-3A	3 Parcel Lockers	150 lbs.
IPL-SA-4A	4 Parcel Lockers	155 lbs.
IPL-SA-5A	5 Parcel Lockers	160 lbs.



People Committed to Quality Since 1936®

# Indoor Parcel Lockers (IPL's)

## eBuy Product Information

### WALL MOUNT INDOOR PARCEL LOCKERS DOUBLE COLUMN REAR LOADING

Made of heavy duty aluminum and stainless steel hardware, Salsbury wall mount double column rear loading indoor parcel lockers (IPL's) are U.S.P.S. approved. Wall mount IPL's are available with standard parcel compartments that are 12" wide x 17" deep with heights varying from 10" (PL3) to 20-1/2" (PL6). All parcel doors include a heavy duty cam lock with a dust/rain shield and three (3) keys. Wall mount IPL units include factory installed 3/4" W x 1/4" D trim. Wall mount units feature two (2) access doors with heavy duty latches and continuous hinges and allow for mail distribution from the rear of the unit. Designed for indoor use, IPL's feature a durable powder coated aluminum finish.



IPL-WM-R-8A  
(7125-17-000-6035)



IPL-WM-R-9A  
(7125-17-000-6036)



IPL-WM-R-10A  
(7125-17-000-6037)

### WALL MOUNT DOUBLE COLUMN REAR LOADING IPL'S

eBuy MODEL #	# of INDOOR PARCEL LOCKERS	WEIGHT
Unit size: 31"W x 63"H x 20"D		
IPL-WM-R-8A	8 Parcel Lockers	160 lbs.
IPL-WM-R-9A	9 Parcel Lockers	165 lbs.
IPL-WM-R-10A	10 Parcel Lockers	170 lbs.

### RACK MOUNT INDOOR PARCEL LOCKERS REAR LOADING

Made of 16 gauge steel and 1/4" thick extruded aluminum, Salsbury rack mount rear loading indoor parcel lockers (IPL's) are USPS approved. Rack mount IPL's offer customers a convenient way to receive packages on site and are fit with a two (2) key security system. Once the recipient opens the parcel locker, the key is automatically retained in the lock until it is removed with a control key. Rack mount IPL's feature a durable powder coated aluminum finish and are equipped with a hinged rear door which allows access from the rear. Rack mount IPL's fit into the 2900 series rack ladder system.



IPL-RM-1RL



IPL-RM-2RL

### RACK MOUNT REAR LOADING IPL'S

eBuy MODEL #	# of INDOOR PARCEL LOCKERS	WEIGHT
Unit size: 23-1/4"W x 12-1/8"H x 16-1/2"D		
IPL-RM-1RL	1 Parcel Locker	35 lbs.
IPL-RM-2RL	2 Parcel Lockers	45 lbs.

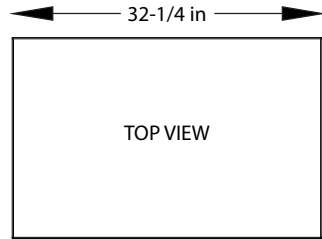

## INDOOR PARCEL LOCKER (IPL) MODEL #: IPL-SA-8A

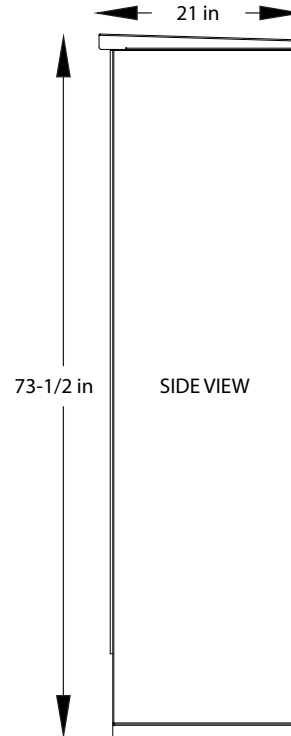
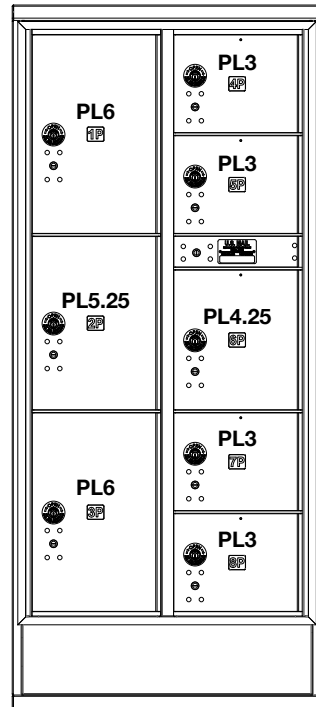

COMPARTMENT SIZES			
TYPE	WIDTH	HEIGHT	DEPTH
PL3	12.00 in	10.00 in	17.00 in
PL4.25	12.00 in	14.375 in	17.00 in
PL5.25	12.00 in	17.875 in	17.00 in
PL6	12.00 in	20.50 in	17.00 in

Each compartment of a Stand Alone Indoor Parcel Locker requires two locks in order to use the compartment, a Tenant lock and a USPS Arrow lock. The Tenant lock for each compartment is included with the purchase of the unit, however, the Arrow lock is not. You will need to order one USPS Arrow lock (PSN 5340070004677) for each compartment separately from the unit from the USPS. Please note that for Stand Alone units, one additional Arrow lock will be required for the Master Door.

Model #: IPL-SA-8A  
Contract #: 3DVDIE-15-B-0039

STAND-ALONE DOUBLE COLUMN  
FRONT LOADING  
INDOOR PARCEL LOCKERS

Unit Weight: 260 lbs.

DRAWN: 01 / 2020

***Established in 1936, Salsbury Industries is the industry leader in manufacturing and distributing quality mailboxes.***



People Committed to Quality Since 1936®

18300 CENTRAL AVENUE  
CARSON, CA 90746-4008  
PHONE: (800) 624-5269  
FAX: (800) 624-5299  
email: eBuy@mailboxes.com



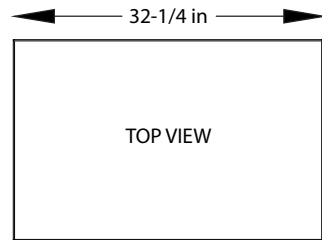

## INDOOR PARCEL LOCKER (IPL) MODEL #: IPL-SA-9A

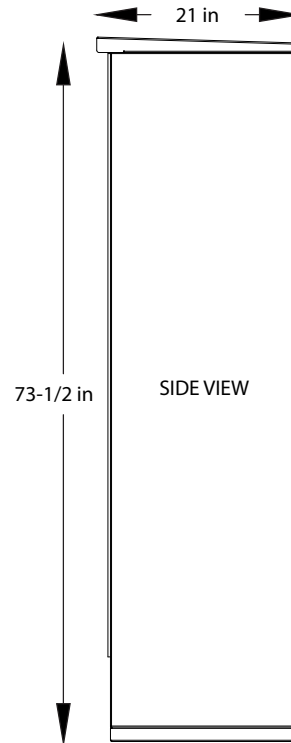
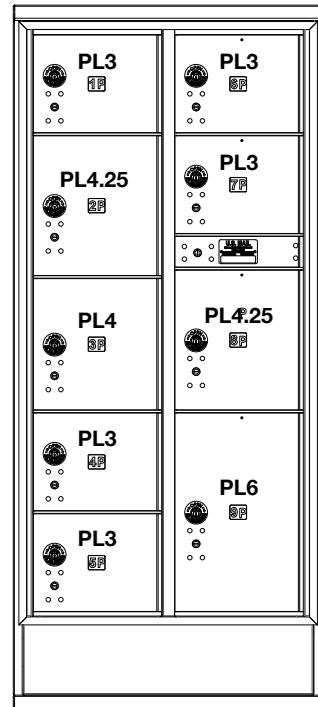

COMPARTMENT SIZES			
TYPE	WIDTH	HEIGHT	DEPTH
PL3	12.00 in	10.00 in	17.00 in
PL4	12.00 in	13.50 in	17.00 in
PL4.25	12.00 in	14.375 in	17.00 in
PL6	12.00 in	20.50 in	17.00 in

Each compartment of a Stand Alone Indoor Parcel Locker requires two locks in order to use the compartment, a Tenant lock and a USPS Arrow lock. The Tenant lock for each compartment is included with the purchase of the unit, however, the Arrow lock is not. You will need to order one USPS Arrow lock (PSN 5340070004677) for each compartment separately from the unit from the USPS. Please note that for Stand Alone units, one additional Arrow lock will be required for the Master Door.

Model #: IPL-SA-9A  
Contract #: 3DVDIE-15-B-0039

STAND-ALONE DOUBLE COLUMN  
FRONT LOADING  
INDOOR PARCEL LOCKERS

Unit Weight: 265 lbs.

DRAWN: 01 / 2020

***Established in 1936, Salsbury Industries is the industry leader in manufacturing and distributing quality mailboxes.***



People Committed to Quality Since 1936<sup>®</sup>

18300 CENTRAL AVENUE  
CARSON, CA 90746-4008  
PHONE: (800) 624-5269  
FAX: (800) 624-5299  
email: eBuy@mailboxes.com

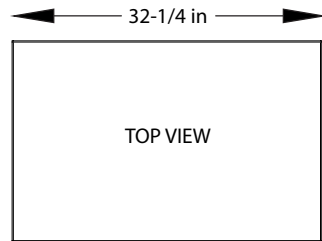

## INDOOR PARCEL LOCKER (IPL) MODEL #: IPL-SA-10A

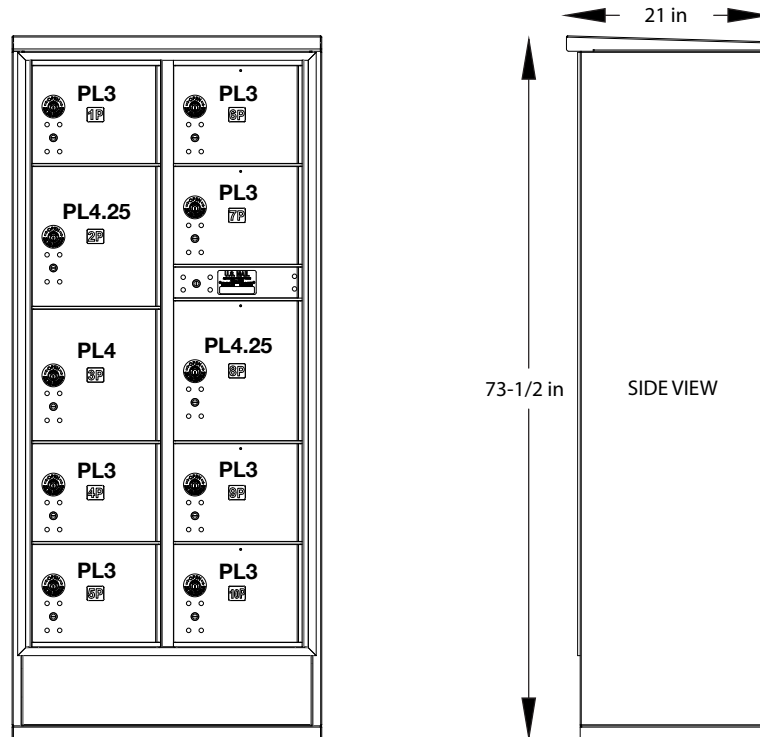

COMPARTMENT SIZES			
TYPE	WIDTH	HEIGHT	DEPTH
PL3	12.00 in	10.00 in	17.00 in
PL4	12.00 in	13.50 in	17.00 in
PL4.25	12.00 in	14.375 in	17.00 in

Each compartment of a Stand Alone Indoor Parcel Locker requires two locks in order to use the compartment, a Tenant lock and a USPS Arrow lock. The Tenant lock for each compartment is included with the purchase of the unit, however, the Arrow lock is not. You will need to order one USPS Arrow lock (PSN 5340070004677) for each compartment separately from the unit from the USPS. Please note that for Stand Alone units, one additional Arrow lock will be required for the Master Door.

Model #: IPL-SA-10A  
Contract #: 3DVDIE-15-B-0039

STAND-ALONE DOUBLE COLUMN  
FRONT LOADING  
INDOOR PARCEL LOCKERS

Unit Weight: 270 lbs.

DRAWN: 01 / 2020

***Established in 1936, Salsbury Industries is the industry leader in manufacturing and distributing quality mailboxes.***



People Committed to Quality Since 1936®

18300 CENTRAL AVENUE  
CARSON, CA 90746-4008  
PHONE: (800) 624-5269  
FAX: (800) 624-5299  
email: eBuy@mailboxes.com

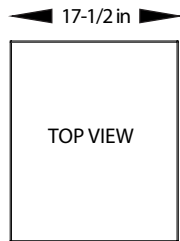

## INDOOR PARCEL LOCKER (IPL) MODEL #: IPL-SA-3A

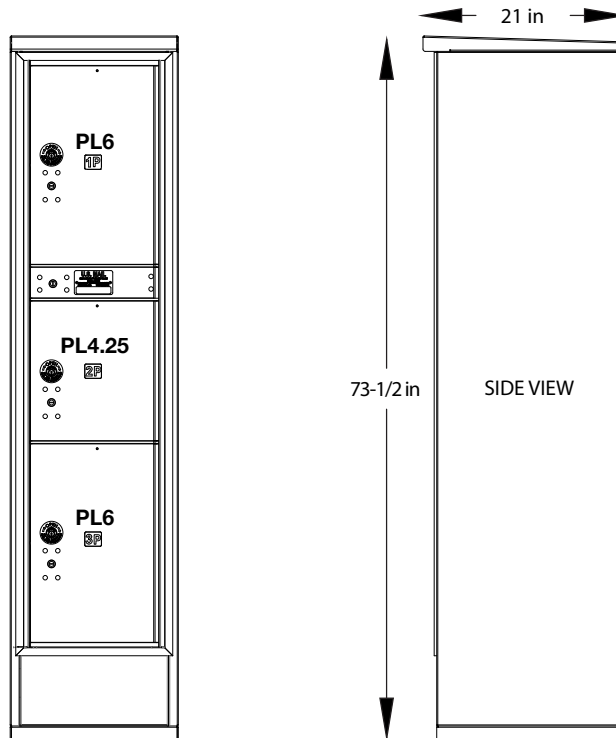

COMPARTMENT SIZES			
TYPE	WIDTH	HEIGHT	DEPTH
PL4.25	12.00 in	14.375 in	17.00 in
PL6	12.00 in	20.50 in	17.00 in

Each compartment of a Stand Alone Indoor Parcel Locker requires two locks in order to use the compartment, a Tenant lock and a USPS Arrow lock. The Tenant lock for each compartment is included with the purchase of the unit, however, the Arrow lock is not. You will need to order one USPS Arrow lock (PSN 5340070004677) for each compartment separately from the unit from the USPS. Please note that for Stand Alone units, one additional Arrow lock will be required for the Master Door.

Model #: IPL-SA-3A  
Contract #: 3DVDIE-15-B-0039

STAND-ALONE SINGLE COLUMN  
FRONT LOADING  
INDOOR PARCEL LOCKERS

Unit Weight: 150 lbs.

DRAWN: 01 / 2020

***Established in 1936, Salsbury Industries is the industry leader in manufacturing and distributing quality mailboxes.***



People Committed to Quality Since 1936<sup>®</sup>

18300 CENTRAL AVENUE  
CARSON, CA 90746-4008  
PHONE: (800) 624-5269  
FAX: (800) 624-5299  
email: eBuy@mailboxes.com

17-1/2 in

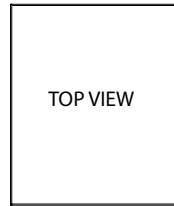

TOP VIEW

## INDOOR PARCEL LOCKER (IPL) MODEL #: IPL-SA-4A

21 in

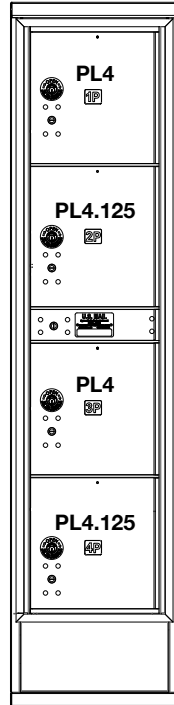

73-1/2 in

SIDE VIEW

COMPARTMENT SIZES			
TYPE	WIDTH	HEIGHT	DEPTH
PL4	12.00 in	13.50 in	17.00 in
PL4.125	12.00 in	13.94 in	17.00 in

Each compartment of a Stand Alone Indoor Parcel Locker requires two locks in order to use the compartment, a Tenant lock and a USPS Arrow lock. The Tenant lock for each compartment is included with the purchase of the unit, however, the Arrow lock is not. You will need to order one USPS Arrow lock (PSN 5340070004677) for each compartment separately from the unit from the USPS. Please note that for Stand Alone units, one additional Arrow lock will be required for the Master Door.

Model #: IPL-SA-4A  
Contract #: 3DVDIE-15-B-0039

STAND-ALONE SINGLE COLUMN  
FRONT LOADING  
INDOOR PARCEL LOCKERS

Unit Weight: 155 lbs.

DRAWN: 01 / 2020

***Established in 1936, Salsbury Industries is the industry leader in manufacturing and distributing quality mailboxes.***



People Committed to Quality Since 1936®

18300 CENTRAL AVENUE  
CARSON, CA 90746-4008  
PHONE: (800) 624-5269  
FAX: (800) 624-5299  
email: eBuy@mailboxes.com

17-1/2 in

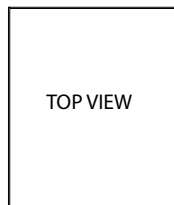

TOP VIEW

## INDOOR PARCEL LOCKER (IPL) MODEL #: IPL-SA-5A

21 in

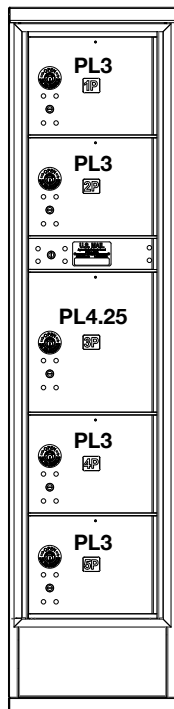

73-1/2 in

SIDE VIEW

COMPARTMENT SIZES			
TYPE	WIDTH	HEIGHT	DEPTH
PL3	12.00 in	10.00 in	17.00 in
PL4.25	12.00 in	14.375 in	17.00 in

Each compartment of a Stand Alone Indoor Parcel Locker requires two locks in order to use the compartment, a Tenant lock and a USPS Arrow lock. The Tenant lock for each compartment is included with the purchase of the unit, however, the Arrow lock is not. You will need to order one USPS Arrow lock (PSN 5340070004677) for each compartment separately from the unit from the USPS. Please note that for Stand Alone units, one additional Arrow lock will be required for the Master Door.

Model #: IPL-SA-5A  
Contract #: 3DVDIE-15-B-0039

STAND-ALONE SINGLE COLUMN  
FRONT LOADING  
INDOOR PARCEL LOCKERS

Unit Weight: 160 lbs.

DRAWN: 01 / 2020

***Established in 1936, Salsbury Industries is the industry leader in manufacturing and distributing quality mailboxes.***



People Committed to Quality Since 1936®

18300 CENTRAL AVENUE  
CARSON, CA 90746-4008  
PHONE: (800) 624-5269  
FAX: (800) 624-5299  
email: eBuy@mailboxes.com



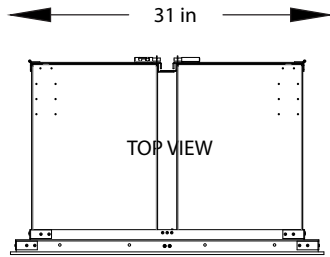

## INDOOR PARCEL LOCKER (IPL) MODEL #: IPL-WM-R-8A

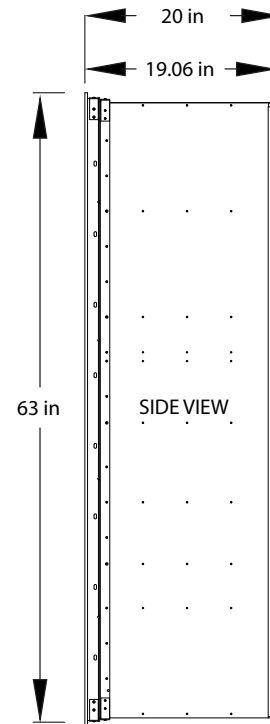
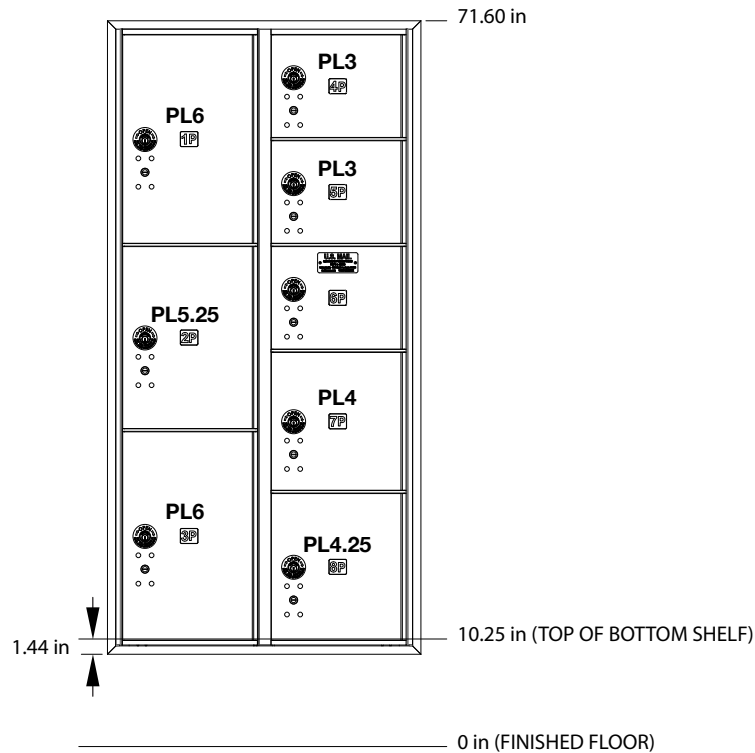

COMPARTMENT SIZES			
TYPE	WIDTH	HEIGHT	DEPTH
PL3	12.00 in	10.00 in	17.00 in
PL4	12.00 in	13.50 in	17.00 in
PL4.25	12.00 in	14.375 in	17.00 in
PL5.25	12.00 in	17.875 in	17.00 in
PL6	12.00 in	20.50 in	17.00 in

Each compartment of a Wall Mounted Indoor Parcel Locker requires two locks in order to use the compartment, a Tenant lock and a USPS Arrow lock. The Tenant lock for each compartment is included with the purchase of the unit, however, the Arrow lock is not. You will need to order one USPS Arrow lock (PSN 5340070004677) for each compartment separately from the unit from the USPS.

Model #: IPL-WM-R-8A  
Contract #: 3DVDIE-15-B-0039

WALL MOUNT DOUBLE COLUMN  
REAR LOADING  
INDOOR PARCEL LOCKERS

Unit Weight: 160 lbs.

DRAWN: 01/2020

***Established in 1936, Salsbury Industries is the industry leader in manufacturing and distributing quality mailboxes.***



People Committed to Quality Since 1936®

18300 CENTRAL AVENUE  
CARSON, CA 90746-4008  
PHONE: (800) 624-5269  
FAX: (800) 624-5299  
email: eBuy@mailboxes.com

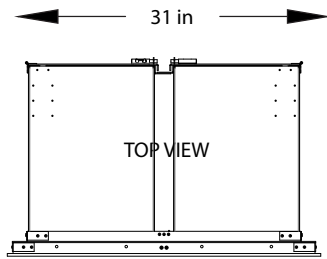

## INDOOR PARCEL LOCKER (IPL) MODEL #: IPL-WM-R-9A

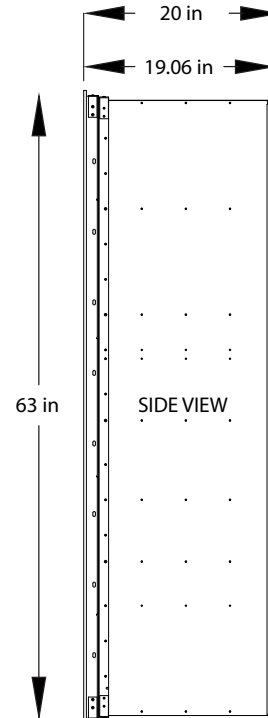
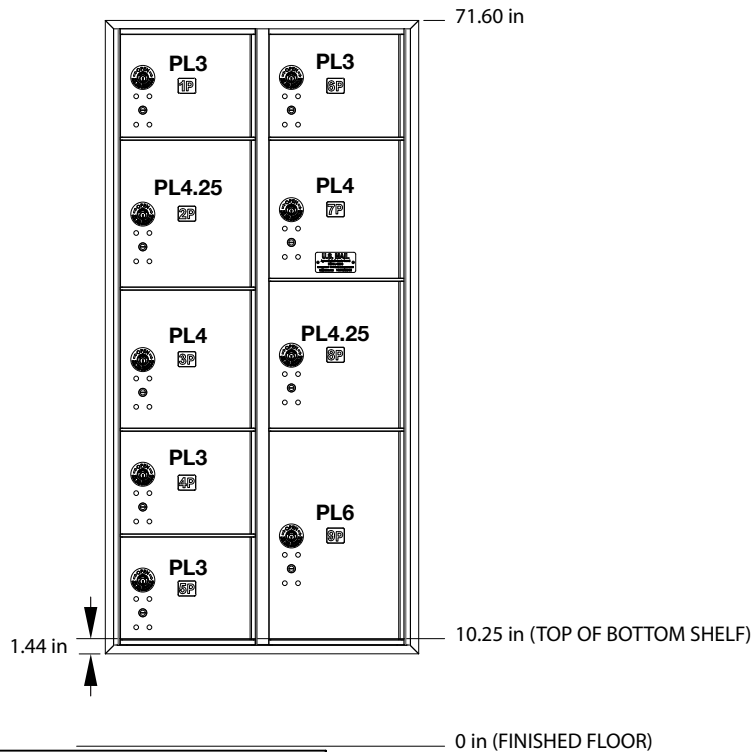

COMPARTMENT SIZES			
TYPE	WIDTH	HEIGHT	DEPTH
PL3	12.00 in	10.00 in	17.00 in
PL4	12.00 in	13.50 in	17.00 in
PL4.25	12.00 in	14.375 in	17.00 in
PL6	12.00 in	20.50 in	17.00 in

Each compartment of a Wall Mounted Indoor Parcel Locker requires two locks in order to use the compartment, a Tenant lock and a USPS Arrow lock. The Tenant lock for each compartment is included with the purchase of the unit, however, the Arrow lock is not. You will need to order one USPS Arrow lock (PSN 5340070004677) for each compartment separately from the unit from the USPS.

Model #: IPL-WM-R-9A  
Contract #: 3DVDIE-15-B-0039

WALL MOUNT DOUBLE COLUMN  
REAR LOADING  
INDOOR PARCEL LOCKERS

Unit Weight: 165 lbs.

DRAWN: 01 / 2020

***Established in 1936, Salsbury Industries is the industry leader in manufacturing and distributing quality mailboxes.***



People Committed to Quality Since 1936®

18300 CENTRAL AVENUE  
CARSON, CA 90746-4008  
PHONE: (800) 624-5269  
FAX: (800) 624-5299  
email: eBuy@mailboxes.com

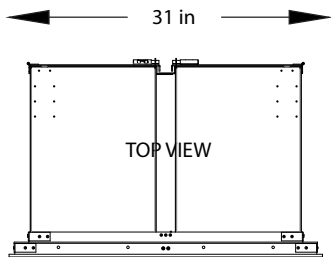

## INDOOR PARCEL LOCKER (IPL) MODEL #: IPL-WM-R-10A

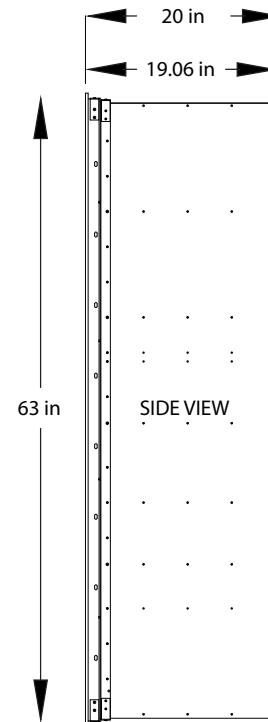
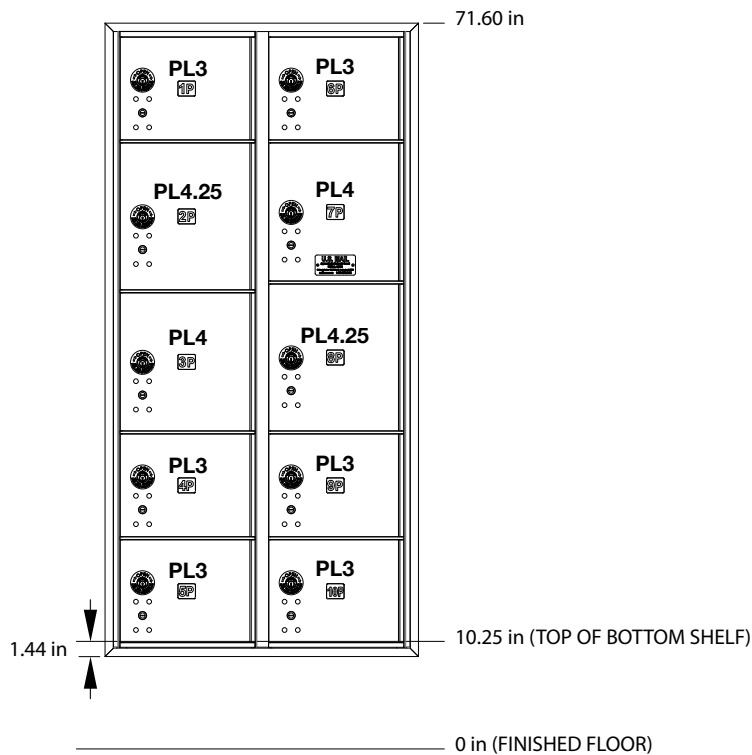

COMPARTMENT SIZES			
TYPE	WIDTH	HEIGHT	DEPTH
PL3	12.00 in	10.00 in	17.00 in
PL4	12.00 in	13.50 in	17.00 in
PL4.25	12.00 in	14.375 in	17.00 in

Each compartment of a Wall Mounted Indoor Parcel Locker requires two locks in order to use the compartment, a Tenant lock and a USPS Arrow lock. The Tenant lock for each compartment is included with the purchase of the unit, however, the Arrow lock is not. You will need to order one USPS Arrow lock (PSN 5340070004677) for each compartment separately from the unit from the USPS.

Model #: IPL-WM-R-10A  
Contract #: 3DVDIE-15-B-0039

WALL MOUNT DOUBLE COLUMN  
REAR LOADING  
INDOOR PARCEL LOCKERS

Unit Weight: 170 lbs.

DRAWN: 01/2020

*Established in 1936, Salsbury Industries is the industry leader in manufacturing and distributing quality mailboxes.*



People Committed to Quality Since 1936®

18300 CENTRAL AVENUE  
CARSON, CA 90746-4008  
PHONE: (800) 624-5269  
FAX: (800) 624-5299  
email: eBuy@mailboxes.com

## INDOOR PARCEL LOCKER (IPL) MODEL #: IPL-RM-1RL

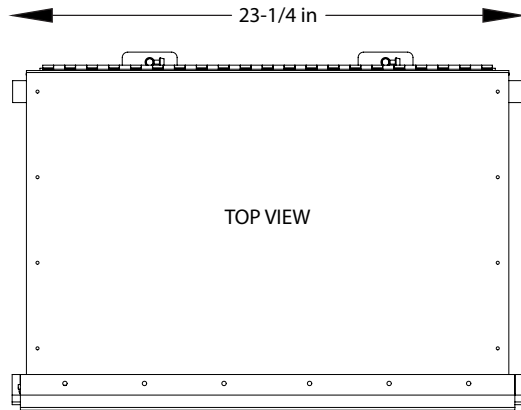

COMPARTMENT SIZE		
WIDTH	HEIGHT	DEPTH
20.50 in	10 in	13.50 in

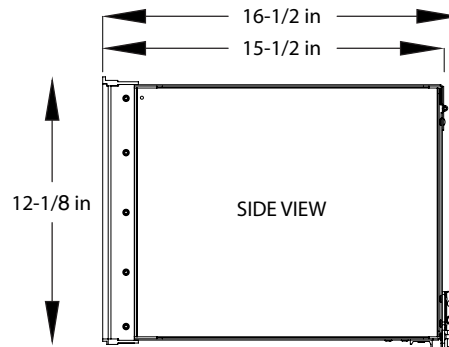
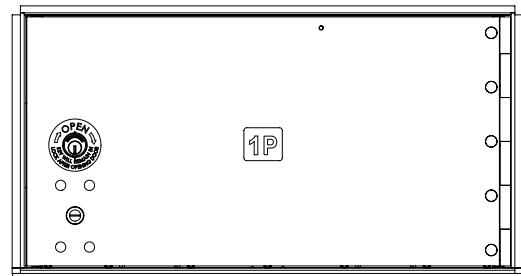

Each compartment of a Rack Mounted Indoor Parcel Locker requires two locks in order to use the compartment, a Tenant lock and a USPS Arrow lock. The Tenant lock for each compartment is included with the purchase of the unit, however, the Arrow lock is not. You will need to order one USPS Arrow lock (PSN 5340070004677) for each compartment separately from the unit from the USPS.

Model #: IPL-RM-1RL  
Contract #: 3DVDIE-15-B-0039

RACK MOUNT  
INDOOR PARCEL LOCKERS for  
2900 SERIES RACK LADDER  
REAR LOADING SYSTEM

Unit Weight: 35 lbs.

DRAWN: 01 / 2020

***Established in 1936, Salsbury Industries is the industry leader in manufacturing and distributing quality mailboxes.***



People Committed to Quality Since 1936®

18300 CENTRAL AVENUE  
CARSON, CA 90746-4008  
PHONE: (800) 624-5269  
FAX: (800) 624-5299  
email: eBuy@mailboxes.com

## INDOOR PARCEL LOCKER (IPL) MODEL #: IPL-RM-2RL

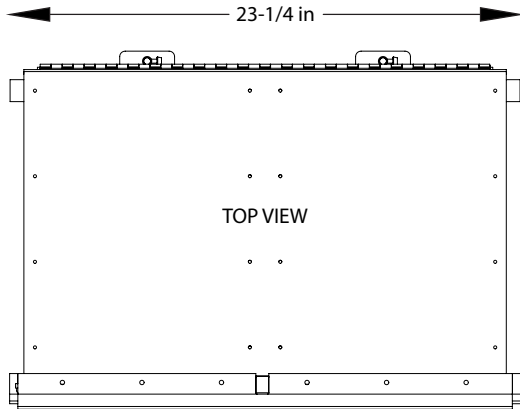

COMPARTMENT SIZES		
WIDTH	HEIGHT	DEPTH
9.31 in	10 in	13.50 in

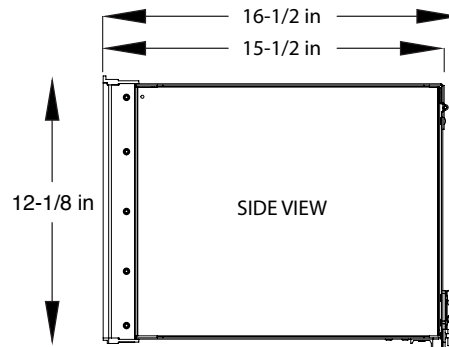
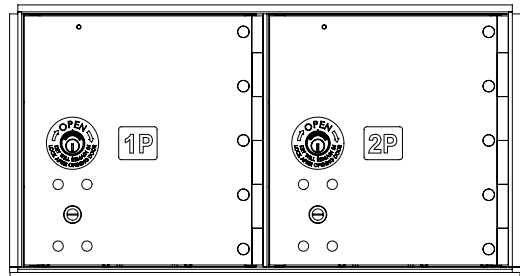

Each compartment of a Rack Mounted Indoor Parcel Locker requires two locks in order to use the compartment, a Tenant lock and a USPS Arrow lock. The Tenant lock for each compartment is included with the purchase of the unit, however, the Arrow lock is not. You will need to order one USPS Arrow lock (PSN 5340070004677) for each compartment separately from the unit from the USPS.

Model #: IPL-RM-2RL  
Contract #: 3DVDIE-15-B-0039

RACK MOUNT  
INDOOR PARCEL LOCKERS for  
2900 SERIES RACK LADDER  
REAR LOADING SYSTEM

Unit Weight: 45 lbs.

DRAWN: 01 / 2020

***Established in 1936, Salsbury Industries is the industry leader in manufacturing and distributing quality mailboxes.***



People Committed to Quality Since 1936<sup>®</sup>

18300 CENTRAL AVENUE  
CARSON, CA 90746-4008  
PHONE: (800) 624-5269  
FAX: (800) 624-5299  
email: eBuy@mailboxes.com