

# CELL PHONE STORAGE LOCKERS

Salsbury Industries offers a complete line of quality cell phone storage lockers for safe and secure storage of cell phones, tablet PCs, wallets, keys and other small valuables. Cell phone storage lockers are ideal for health clubs, government facilities, schools, universities, hospitals, military bases and high security locations. Cell phone lockers are available as surface mounted or recessed mounted units. Salsbury lockers can be ordered by phone or online at [www.mailboxes.com](http://www.mailboxes.com).

**mailboxes.com**  
1-800-MAILBOX



**SALSBURY**  
INDUSTRIES

*People Committed to Quality Since 1936*

# CELL PHONE STORAGE LOCKERS

## Cell Phone Lockers - Surface Mounted



## CELL PHONE LOCKERS - SURFACE MOUNTED

- Made entirely of heavy duty aluminum and feature a durable powder coated finish in a variety of colors.
- Ideal for use in athletic facilities, health clubs, office buildings, schools and other settings where small personal items need to be stored safely and securely.
- Available in five (5) and seven (7) doors high and three (3), four (4) and five (5) doors wide with standard "A" size doors (6-1/2" W x 5-1/4" H) and larger "B" size doors (13" W x 5-1/4" H).
- Cell phone lockers are available with master keyed locks or resettable combination locks.

### STANDARD CONFIGURATIONS

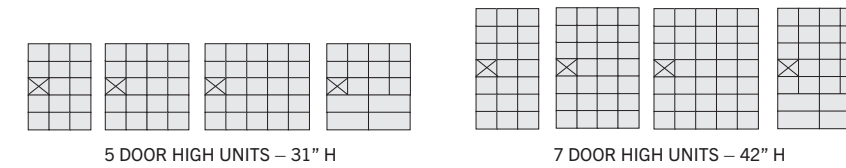

### OPTIONS

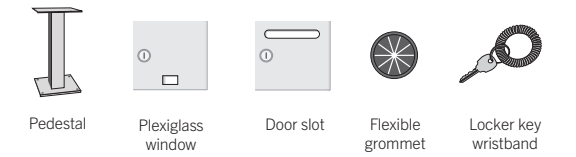

Custom configurations available (Minimum order of ten (10) units)

To view all cell phone lockers visit: [www.mailboxes.com/cell-phone-storage-lockers/](http://www.mailboxes.com/cell-phone-storage-lockers/)

### COLOR OPTIONS

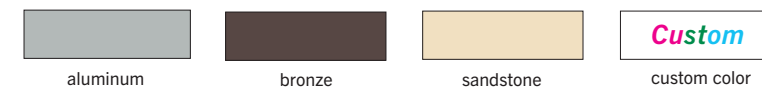

Custom colors available (Minimum order of ten (10) units)

To view all custom colors visit: [www.mailboxes.com/cell-phone-storage-lockers/custom-cell-phone-lockers/](http://www.mailboxes.com/cell-phone-storage-lockers/custom-cell-phone-lockers/)

### LOCK OPTIONS / NUMBER PLATES

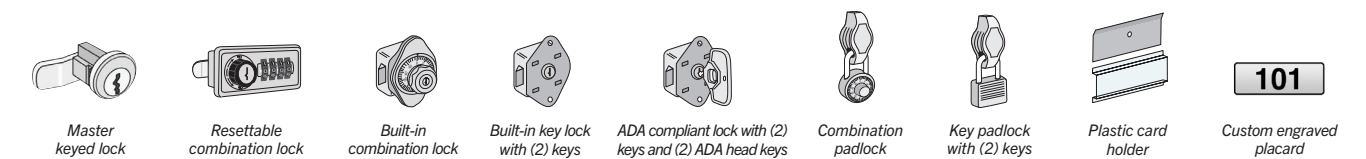

### CELL PHONE LOCKER INSTALLATIONS

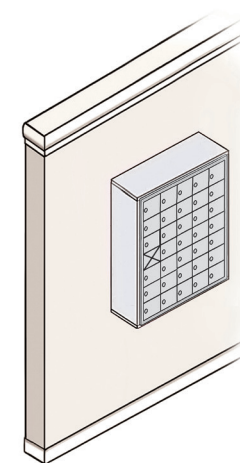

SURFACE MOUNTED

- Ideal where wall depth is limited
- Mount directly to a wall
- Front access panel swings on a continuous hinge

### Online Resources

- Product Information
- 3D Revit / BIM Models
- Detailed Specifications
- Technical Drawings
- Augmented Reality (AR) Models
- Installation Instructions
- AutoCAD Drawings

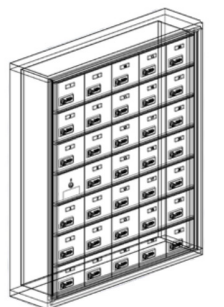

Visit: [www.mailboxes.com/Architectural-Resources](http://www.mailboxes.com/Architectural-Resources)

# CELL PHONE STORAGE LOCKERS

## Cell Phone Lockers - Recessed Mounted



## CELL PHONE LOCKERS - RECESSED MOUNTED

- Made entirely of heavy duty aluminum and feature a durable powder coated finish in a variety of colors.
- Ideal for use in athletic facilities, health clubs, office buildings, schools and other settings where small personal items need to be stored safely and securely.
- Available in five (5) and seven (7) doors high and three (3), four (4) and five (5) doors wide with standard "A" size doors (6-1/2" W x 5-1/4" H) and larger "B" size doors (13" W x 5-1/4" H).
- Cell phone lockers are available with master keyed locks or resettable combination locks.

### STANDARD CONFIGURATIONS

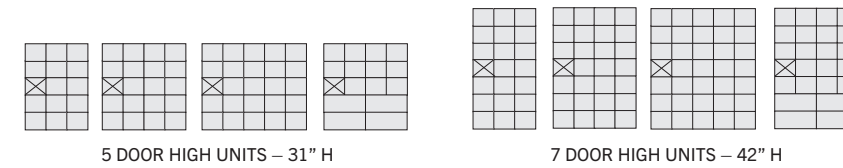

### OPTIONS

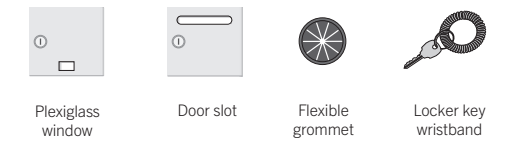

Custom configurations available (Minimum order of ten (10) units)

To view all cell phone lockers visit: [www.mailboxes.com/cell-phone-storage-lockers/](http://www.mailboxes.com/cell-phone-storage-lockers/)

### COLOR OPTIONS



Custom colors available (Minimum order of ten (10) units)

To view all custom colors visit: [www.mailboxes.com/cell-phone-storage-lockers/custom-cell-phone-lockers/](http://www.mailboxes.com/cell-phone-storage-lockers/custom-cell-phone-lockers/)

### LOCK OPTIONS / NUMBER PLATES

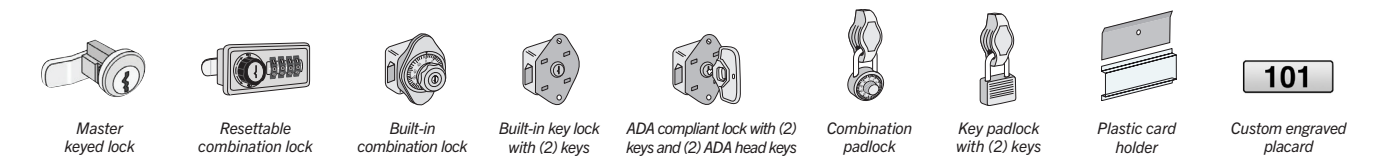

### CELL PHONE LOCKER INSTALLATIONS

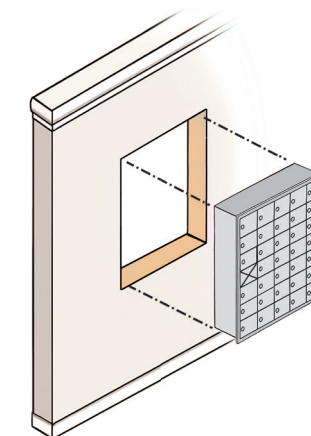

RECESSED MOUNTED

- Ideal for flush mounted installations
- Fits into rough opening and includes flanged collar to fit over opening
- Front access panel swings on a continuous hinge

### Online Resources

- Product Information
- 3D Revit / BIM Models
- Detailed Specifications
- Technical Drawings
- Augmented Reality (AR) Models
- Installation Instructions
- AutoCAD Drawings

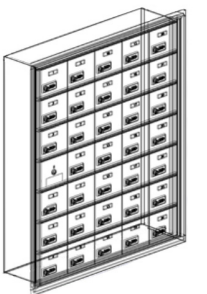

Visit: [www.mailboxes.com/Architectural-Resources](http://www.mailboxes.com/Architectural-Resources)

# CELL PHONE STORAGE LOCKERS

## Cell Phone Locker Enclosures



Enclosure displayed with recessed mounted cell phone locker



## CELL PHONE LOCKERS ENCLOSURES

- Made entirely of heavy duty aluminum and feature a durable powder coated finish in a variety of colors.
- Ideal for health clubs, office buildings, schools and universities, high security locations and many other applications.
- Designed to accommodate Salsbury 19100 Series recessed mounted cell phone lockers (cell phone lockers sold separately).
- Can accommodate 8" deep cell phone lockers in five (5) and seven (7) doors high and three (3), four (4) and five (5) doors wide.

### STANDARD CONFIGURATIONS - Order cell phone lockers separately

#### 5 DOOR HIGH ENCLOSURES

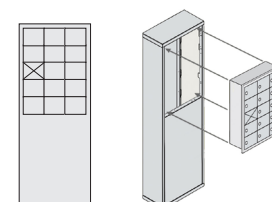

3 DOOR WIDE

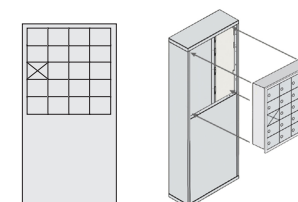

4 DOOR WIDE

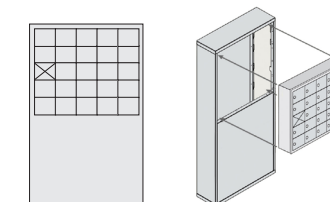

5 DOOR WIDE

#### 7 DOOR HIGH ENCLOSURES

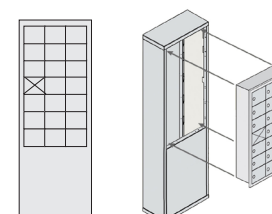

3 DOOR WIDE

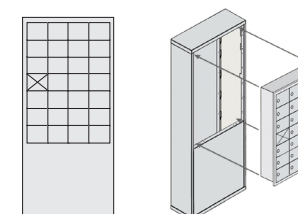

4 DOOR WIDE

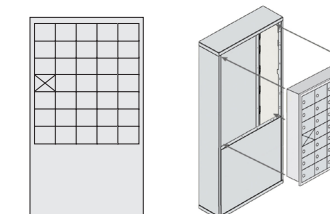

5 DOOR WIDE

### COLOR OPTIONS

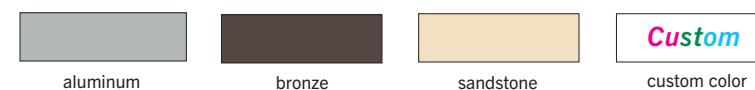

Custom colors available (Minimum order of ten (10) units)

To view all custom colors visit: [www.mailboxes.com/cell-phone-storage-lockers/custom-cell-phone-lockers/](http://www.mailboxes.com/cell-phone-storage-lockers/custom-cell-phone-lockers/)

### CELL PHONE LOCKER ENCLOSURE INSTALLATION

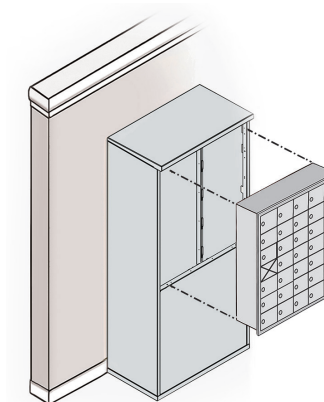

- Ideal when surface mounted or recessed mounted wall application is not desired or available
- Recessed mounted cell phone lockers easily fit into fully assembled enclosures
- Front access panel swings on a continuous hinge

ENCLOSURE DISPLAYED WITH 7 DOOR HIGH RECESSED MOUNTED CELL PHONE LOCKER

### Online Resources

- Product Information
- Installation Instructions
- 3D Revit / BIM Models
- AutoCAD Drawings
- Detailed Specifications
- Technical Drawings
- Augmented Reality (AR) Models



Visit: [www.mailboxes.com/Architectural-Resources](http://www.mailboxes.com/Architectural-Resources)

# CELL PHONE STORAGE LOCKERS

## Custom Cell Phone Lockers



## CUSTOM CELL PHONE LOCKERS

- Made entirely of heavy duty aluminum and feature a durable powder coated finish in a variety of colors.
- Ideal for use in athletic facilities, health clubs, office buildings, schools and other settings where small personal items need to be stored safely and securely.
- Custom cell phone lockers are available in four (4) different locker door sizes and a variety of configurations.
- Custom cell phone lockers are available with master keyed locks or resettable combination locks.

### DOOR SIZES

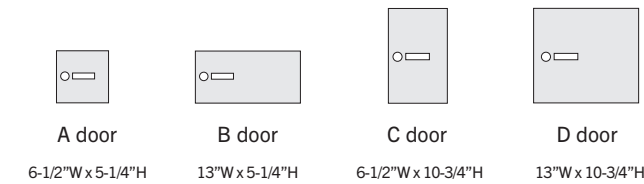

### OPTIONS



Custom configurations available (Minimum order of ten (10) units)

To view all custom cell phone lockers visit: [www.mailboxes.com/cell-phone-storage-lockers/custom-cell-phone-lockers/](http://www.mailboxes.com/cell-phone-storage-lockers/custom-cell-phone-lockers/)

### COLOR OPTIONS

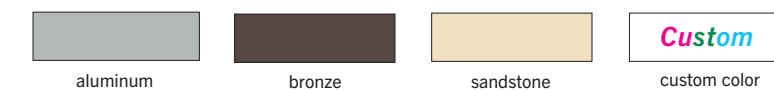

Custom colors available (Minimum order of ten (10) units)

To view all custom colors visit: [www.mailboxes.com/cell-phone-storage-lockers/custom-cell-phone-lockers/](http://www.mailboxes.com/cell-phone-storage-lockers/custom-cell-phone-lockers/)

### LOCK OPTIONS / NUMBER PLATES

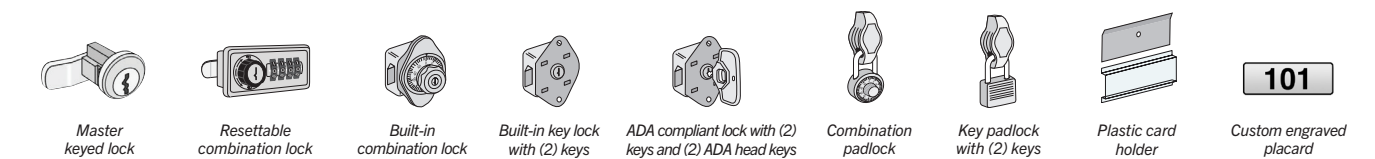

### Custom Cell Phone Lockers

(Minimum order of 10 units)

Configure requirements to fit a minimum of 2W x 3H (A) size doors to a maximum of 5W x 7H (A) doors.

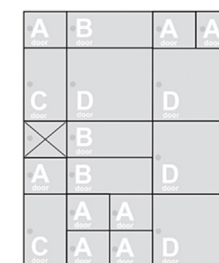

SAMPLE CUSTOM UNIT  
WITH FRONT ACCESS

Contact us for rough  
opening dimensions  
or layout specifications.

Email: [customerservice@mailboxes.com](mailto:customerservice@mailboxes.com)

Phone: 1.800.562.5377

Fax: 1.800.562.5399

[www.mailboxes.com/custom-cell-phone-lockers/](http://www.mailboxes.com/custom-cell-phone-lockers/)

### Online Resources

- Product Information
- Installation Instructions
- 3D Revit / BIM Models
- AutoCAD Drawings
- Detailed Specifications
- Technical Drawings
- Augmented Reality (AR) Models



Visit: [www.mailboxes.com/Architectural-Resources](http://www.mailboxes.com/Architectural-Resources)

# MANUFACTURING SINCE 1936

# ORDER FACTORY DIRECT *Large Inventory and Fast Shipping*



# SALSBURY INDUSTRIES

Contact us to learn more about  
Cell Phone Storage Locker needs!

**Discounts Available!**  
**Contact Us**  
**for a Quote Today!**



People Committed to Quality Since 1936®

**Salsbury Industries**  
18300 Central Avenue  
Carson CA 90746-4008

phone: 1.800.624.5269

fax: 1.800.624.5299

phone: 1.323.846.6700

fax: 1.323.846.6800

email: [salsbury@mailboxes.com](mailto:salsbury@mailboxes.com)

website: [www.mailboxes.com](http://www.mailboxes.com)

