

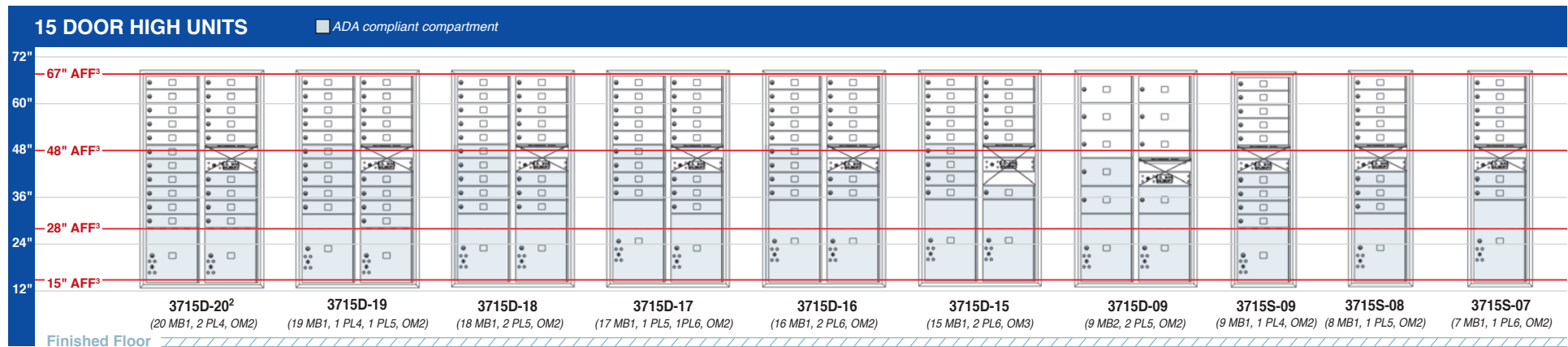

Note: All units are shown mounted as low as the USPS mounting height requirements permit to maximize the number of compartments (indicated in the shaded areas) that fall below the ADA upper reach limit of 48". Consult with local authorities for specific standards.

(Revised 02/10/2017)

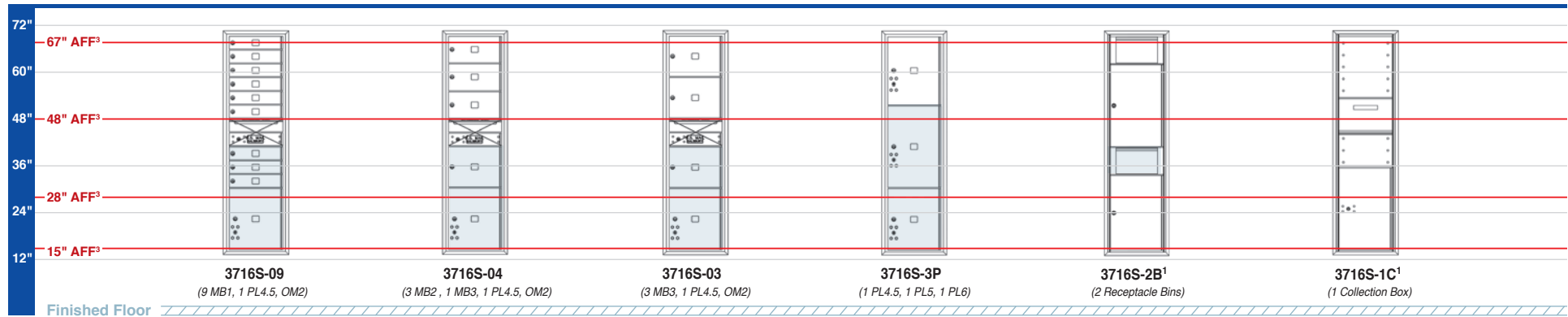
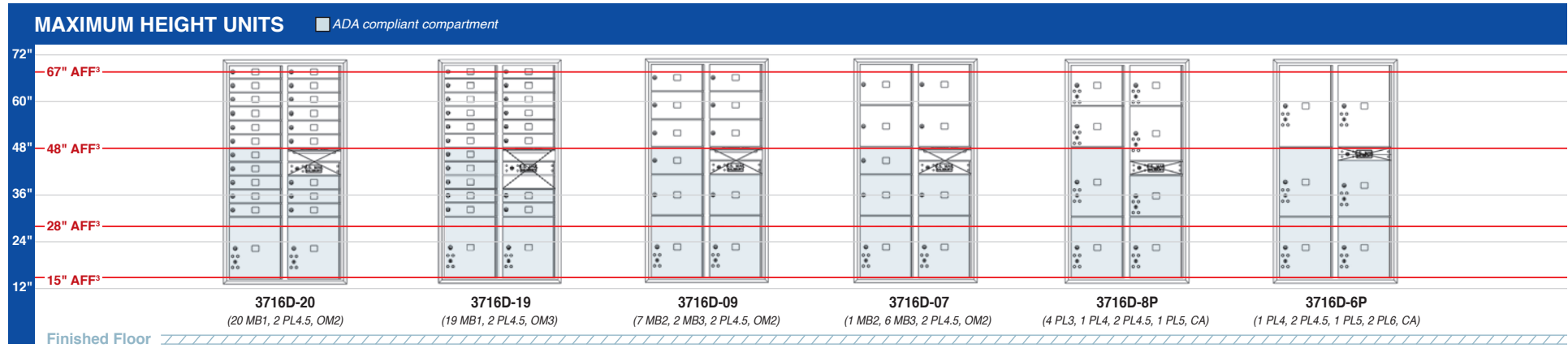

1 - Note: These units do not meet U.S.P.S. installation requirements and are for private delivery only unless approved by local postal authorities.

2 - For private delivery, unless parcel locker ratio exceeds requirement. U.S.P.S. standard 4C requires a minimum of one parcel locker for every ten (10) tenant compartments. Parcel lockers must be a minimum of 15" high (PL4.5, PL5 and PL6) to meet the 1:10 ratio. Once this ratio has been met, smaller parcel lockers (PL3 and PL4) may also be added.

3 - AFF=Above Finished Floor.

Copyright © 2015 Salsbury Industries. All rights reserved.

Note: All units are shown mounted as low as the USPS mounting height requirements permit to maximize the number of compartments (indicated in the shaded areas) that fall below the ADA upper reach limit of 48". Consult with local authorities for specific standards.

(Revised 02/10/2017)

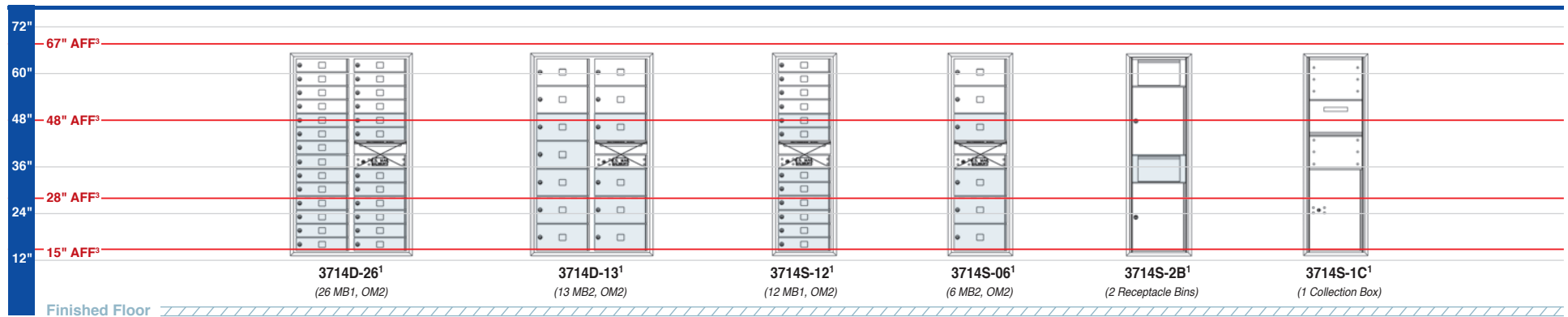
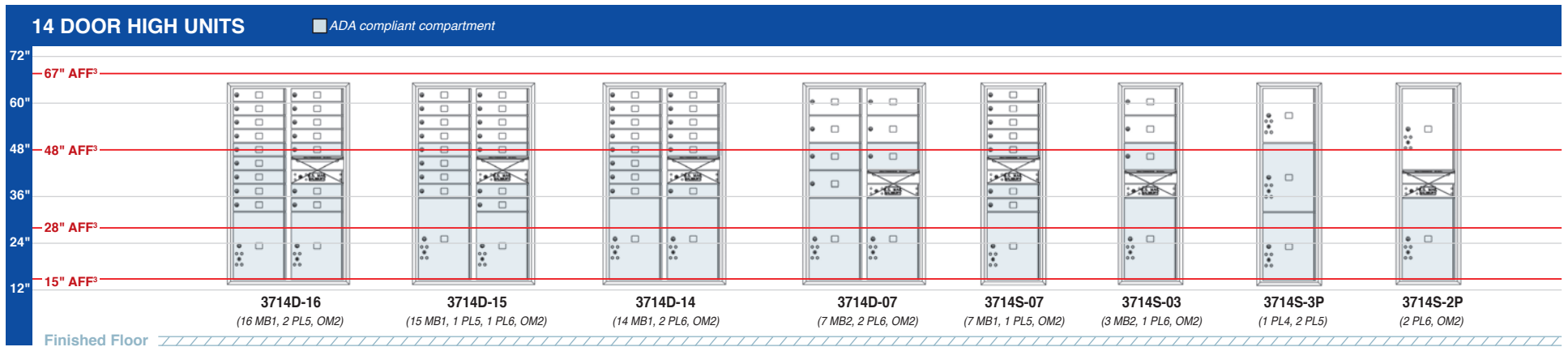
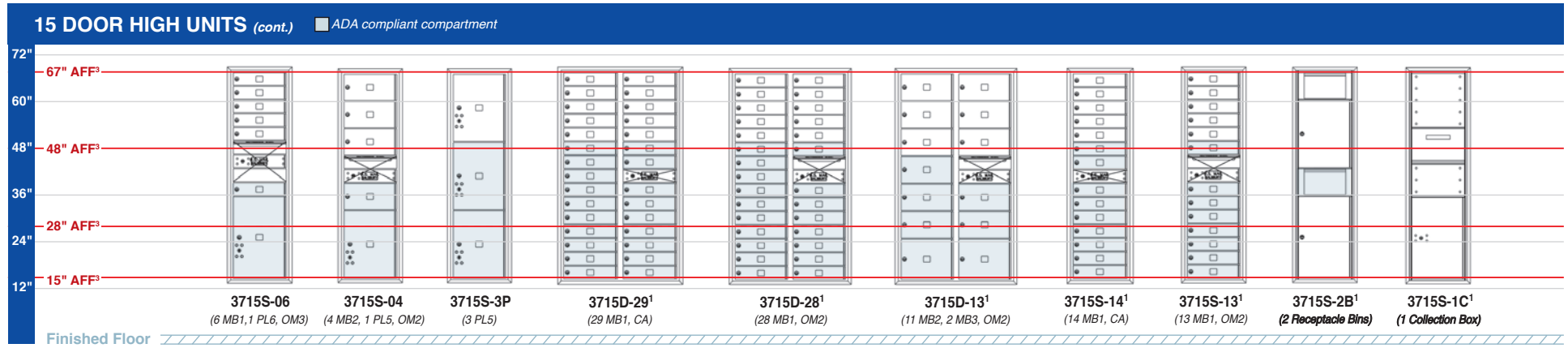

1 - Note: These units do not meet U.S.P.S. installation requirements and are for private delivery only unless approved by local postal authorities.

2 - For private delivery, unless parcel locker ratio exceeds requirement. U.S.P.S. standard 4C requires a minimum of one parcel locker for every ten (10) tenant compartments. Parcel lockers must be a minimum of 15" high (PL4.5, PL5 and PL6) to meet the 1:10 ratio. Once this ratio has been met, smaller parcel lockers (PL3 and PL4) may also be added.

3 - AFF=Above Finished Floor.

Copyright © 2015 Salsbury Industries. All rights reserved.



Note: All units are shown mounted as low as the USPS mounting height requirements permit to maximize the number of compartments (indicated in the shaded areas) that fall below the ADA upper reach limit of 48". Consult with local authorities for specific standards.

(Revised 02/10/2017)

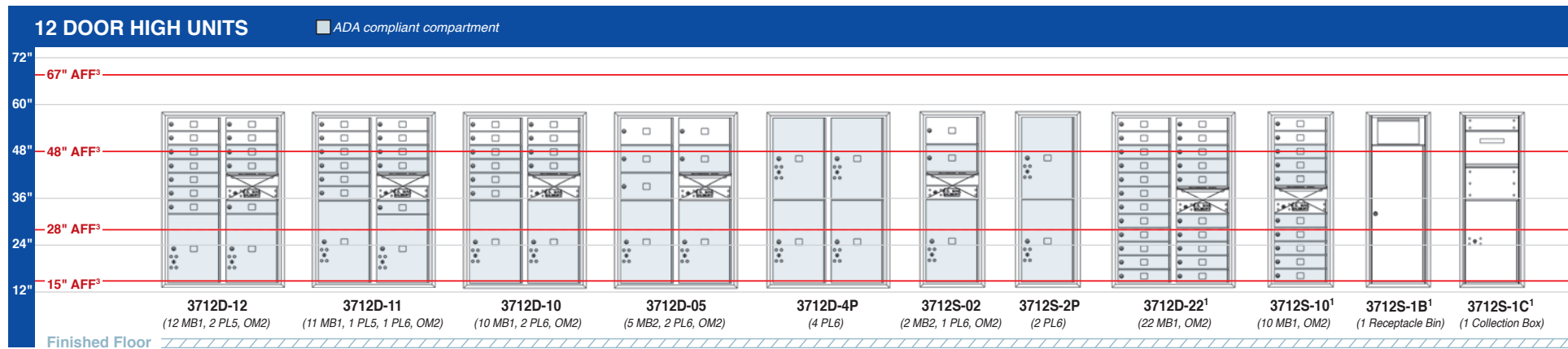
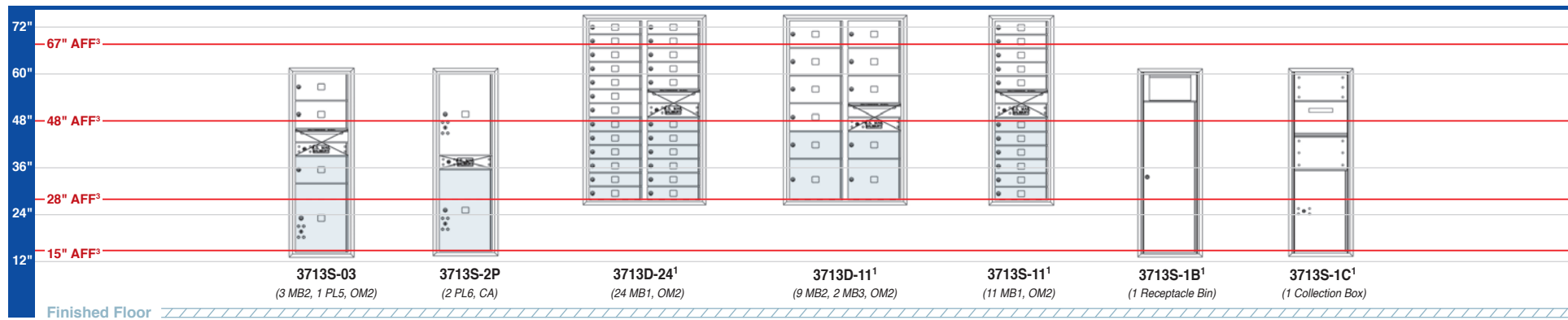
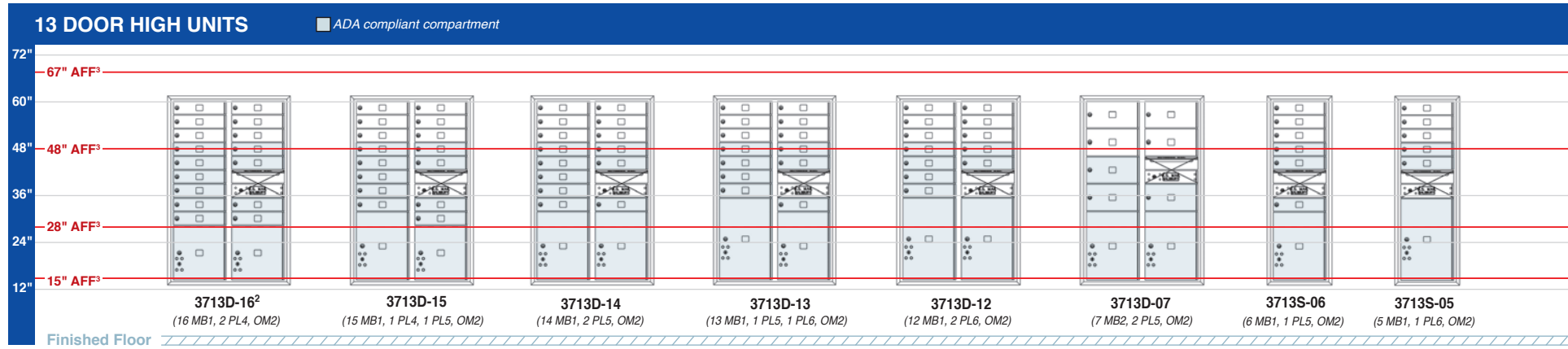

1 - Note: These units do not meet U.S.P.S. installation requirements and are for private delivery only unless approved by local postal authorities.

2 - For private delivery, unless parcel locker ratio exceeds requirement. U.S.P.S. standard 4C requires a minimum of one parcel locker for every ten (10) tenant compartments. Parcel lockers must be a minimum of 15" high (PL4.5, PL5 and PL6) to meet the 1:10 ratio. Once this ratio has been met, smaller parcel lockers (PL3 and PL4) may also be added.

3 - AFF=Above Finished Floor.

Copyright © 2015 Salsbury Industries. All rights reserved.

Note: All units are shown mounted as low as the USPS mounting height requirements permit to maximize the number of compartments (indicated in the shaded areas) that fall below the ADA upper reach limit of 48". Consult with local authorities for specific standards.

(Revised 02/10/2017)

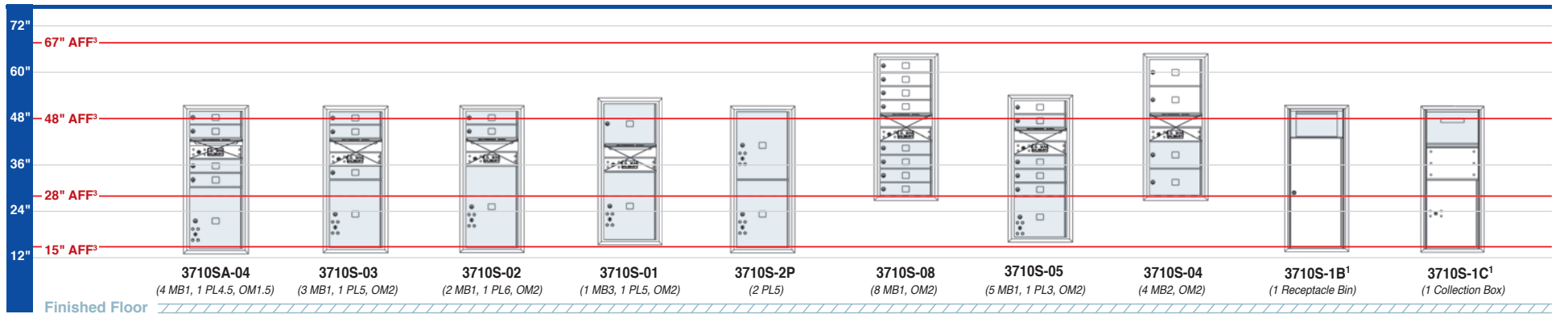
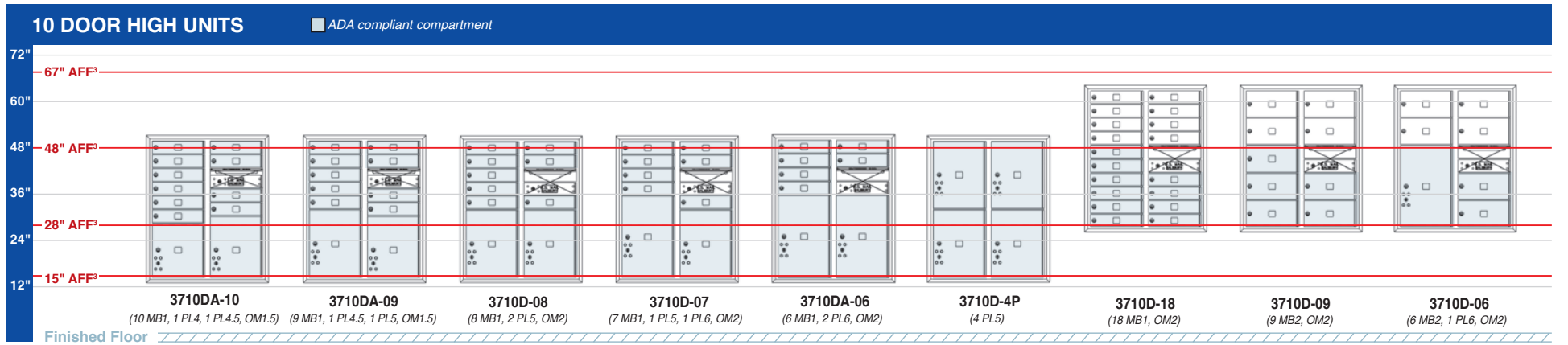
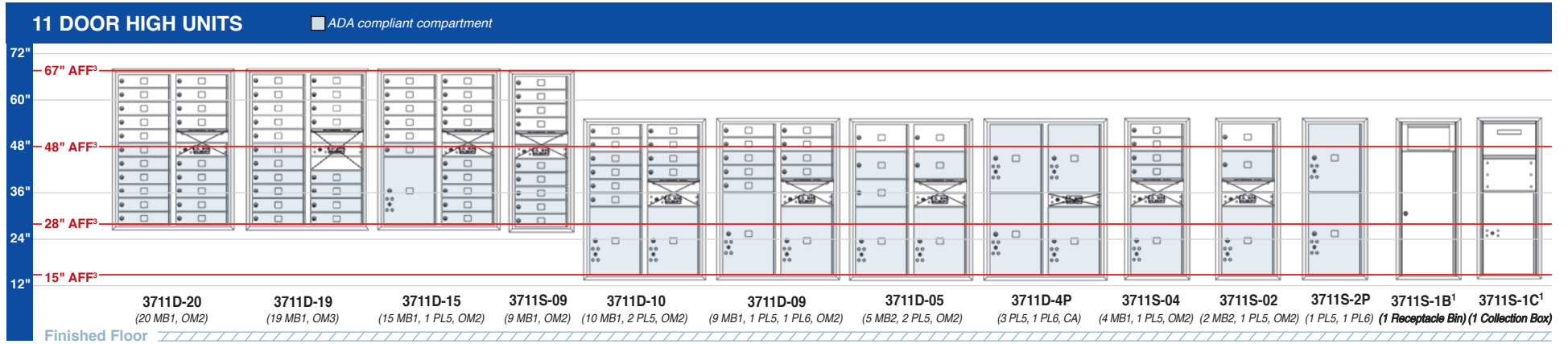

1 - Note: These units do not meet U.S.P.S. installation requirements and are for private delivery only unless approved by local postal authorities.

2 - For private delivery, unless parcel locker ratio exceeds requirement. U.S.P.S. standard 4C requires a minimum of one parcel locker for every ten (10) tenant compartments. Parcel lockers must be a minimum of 15" high (PL4.5, PL5 and PL6) to meet the 1:10 ratio. Once this ratio has been met, smaller parcel lockers (PL3 and PL4) may also be added.

3 - AFF=Above Finished Floor.

Copyright © 2015 Salsbury Industries. All rights reserved.



Note: All units are shown mounted as low as the USPS mounting height requirements permit to maximize the number of compartments (indicated in the shaded areas) that fall below the ADA upper reach limit of 48". Consult with local authorities for specific standards.

(Revised 02/10/2017)

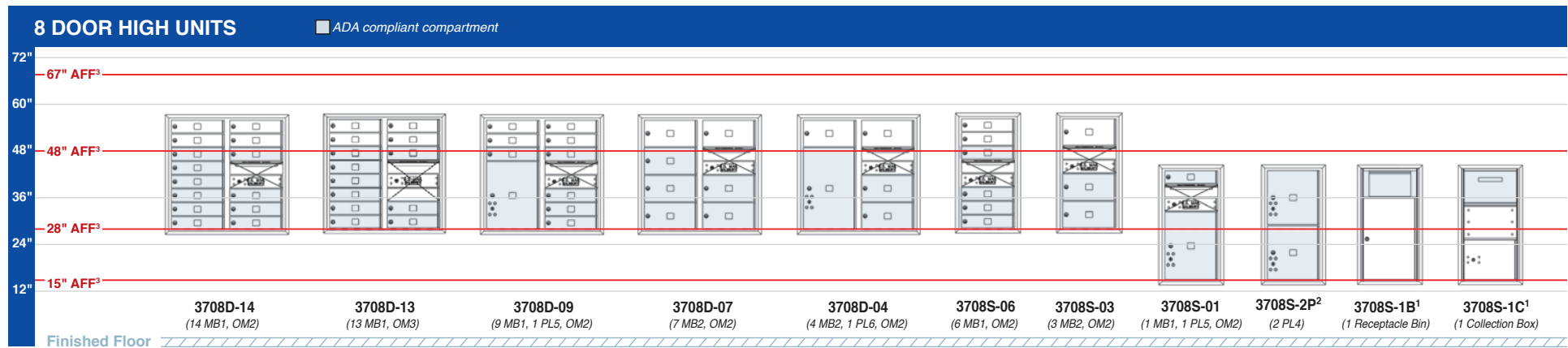
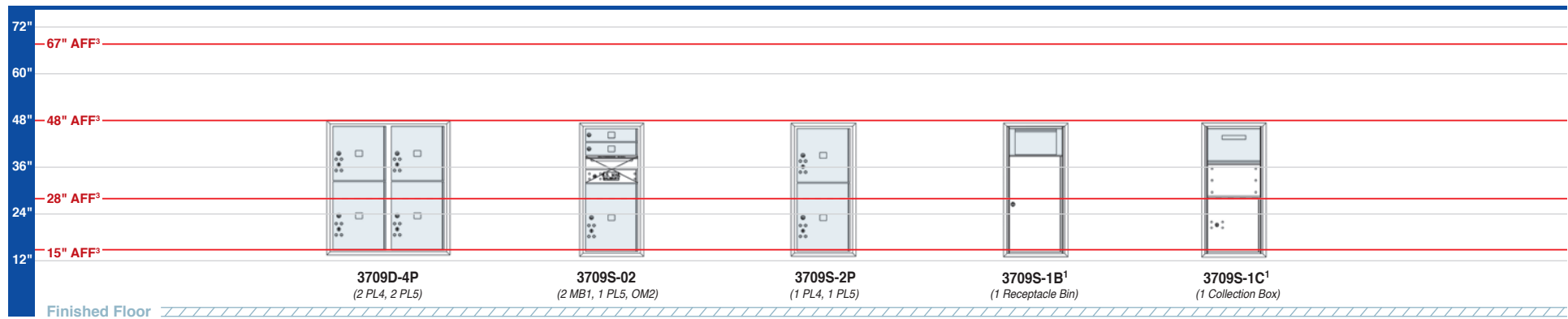
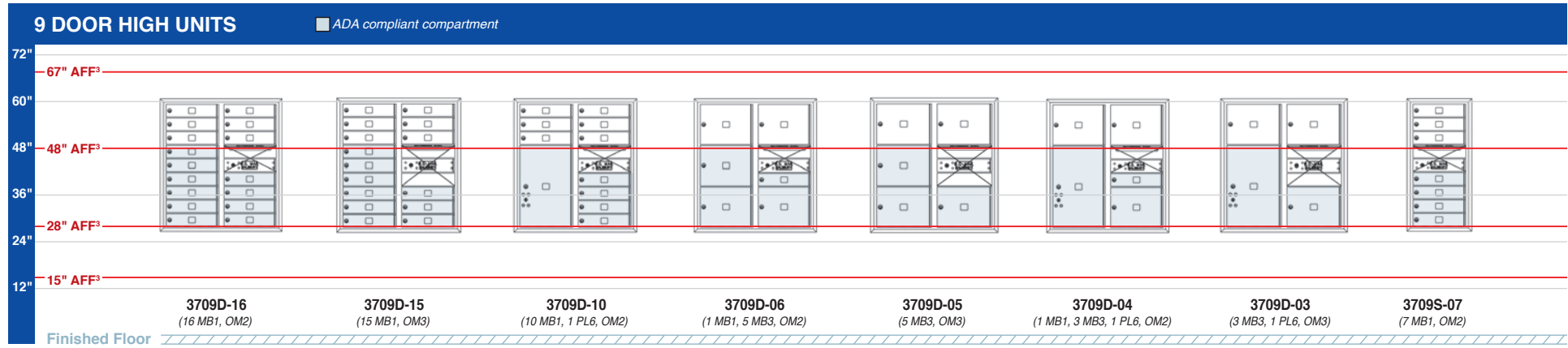

1 - Note: These units do not meet U.S.P.S. installation requirements and are for private delivery only unless approved by local postal authorities.

2 - For private delivery, unless parcel locker ratio exceeds requirement. U.S.P.S. standard 4C requires a minimum of one parcel locker for every ten (10) tenant compartments. Parcel lockers must be a minimum of 15" high (PL4.5, PL5 and PL6) to meet the 1:10 ratio. Once this ratio has been met, smaller parcel lockers (PL3 and PL4) may also be added.

3 - AFF=Above Finished Floor.

Copyright © 2015 Salsbury Industries. All rights reserved.

Note: All units are shown mounted as low as the USPS mounting height requirements permit to maximize the number of compartments (indicated in the shaded areas) that fall below the ADA upper reach limit of 48". Consult with local authorities for specific standards.

(Revised 02/10/2017)

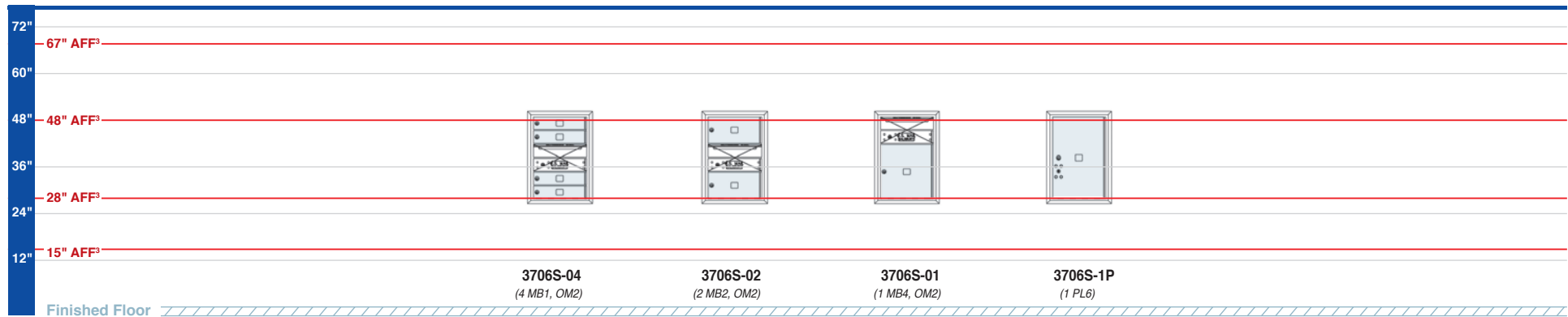
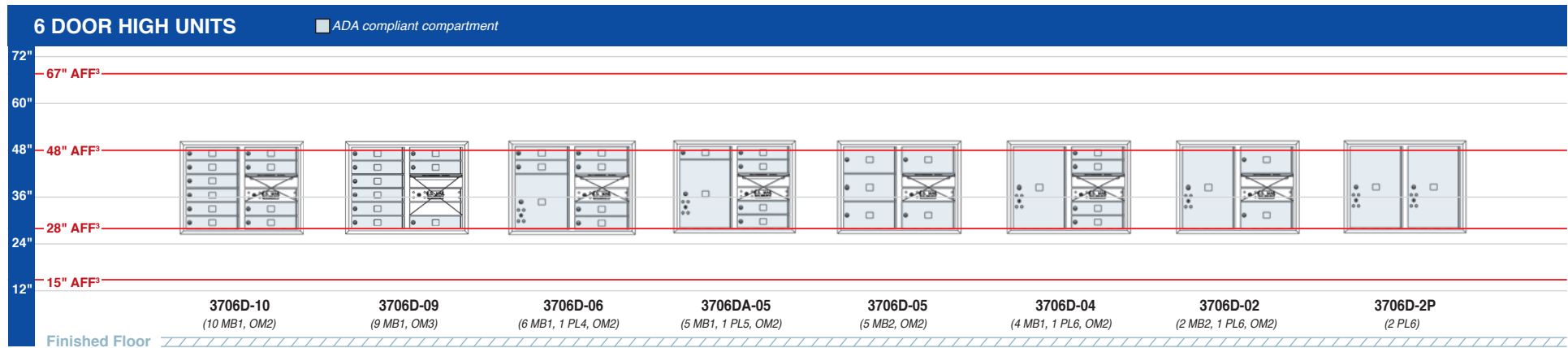
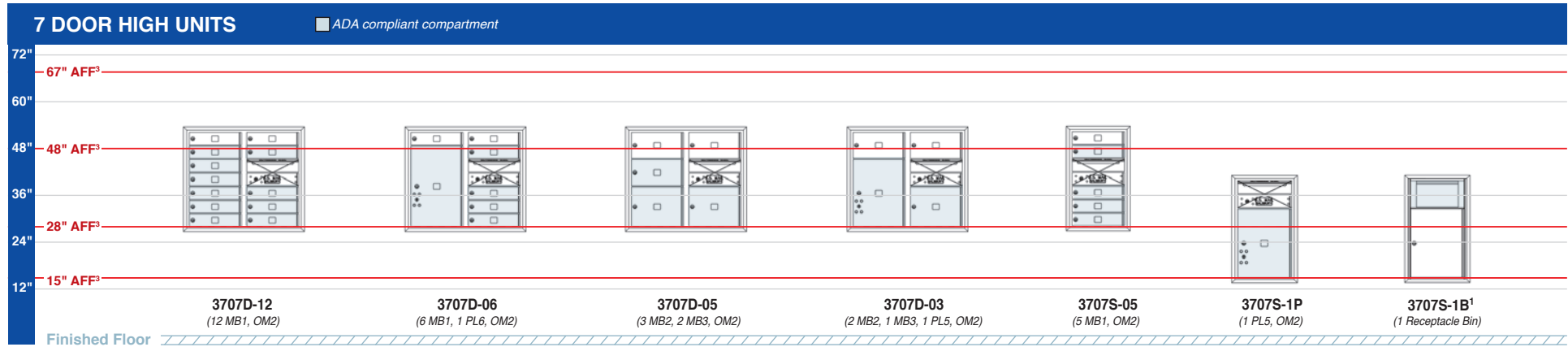

1 - Note: These units do not meet U.S.P.S. installation requirements and are for private delivery only unless approved by local postal authorities.

2 - For private delivery, unless parcel locker ratio exceeds requirement. U.S.P.S. standard 4C requires a minimum of one parcel locker for every ten (10) tenant compartments. Parcel lockers must be a minimum of 15" high (PL4.5, PL5 and PL6) to meet the 1:10 ratio. Once this ratio has been met, smaller parcel lockers (PL3 and PL4) may also be added.

3 - AFF=Above Finished Floor.

Copyright © 2015 Salsbury Industries. All rights reserved.

Note: All units are shown mounted as low as the USPS mounting height requirements permit to maximize the number of compartments (indicated in the shaded areas) that fall below the ADA upper reach limit of 48". Consult with local authorities for specific standards.

(Revised 02/10/2017)

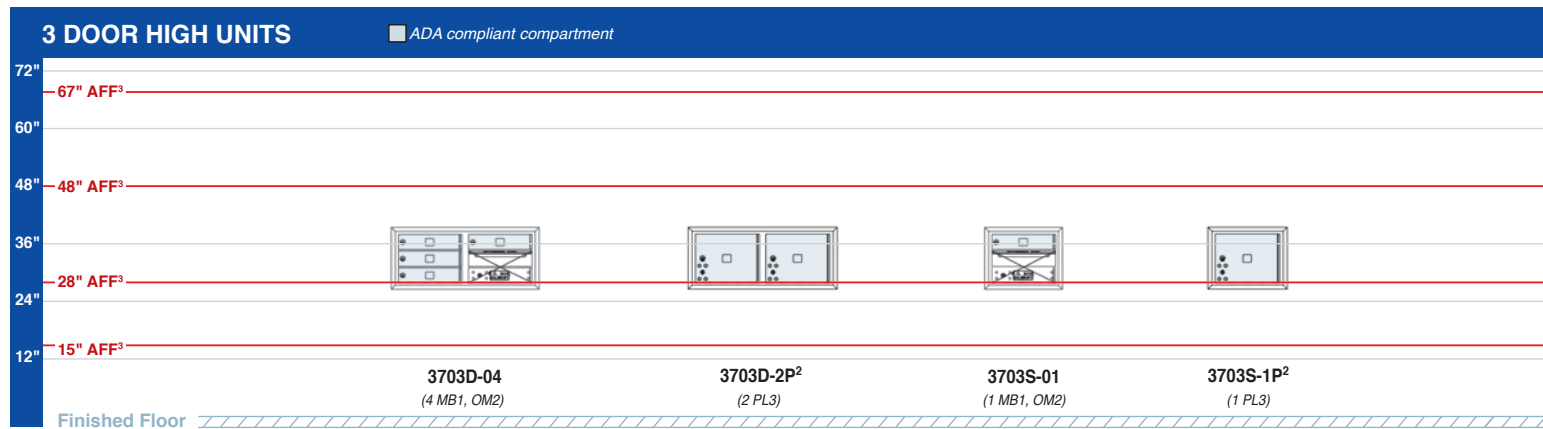
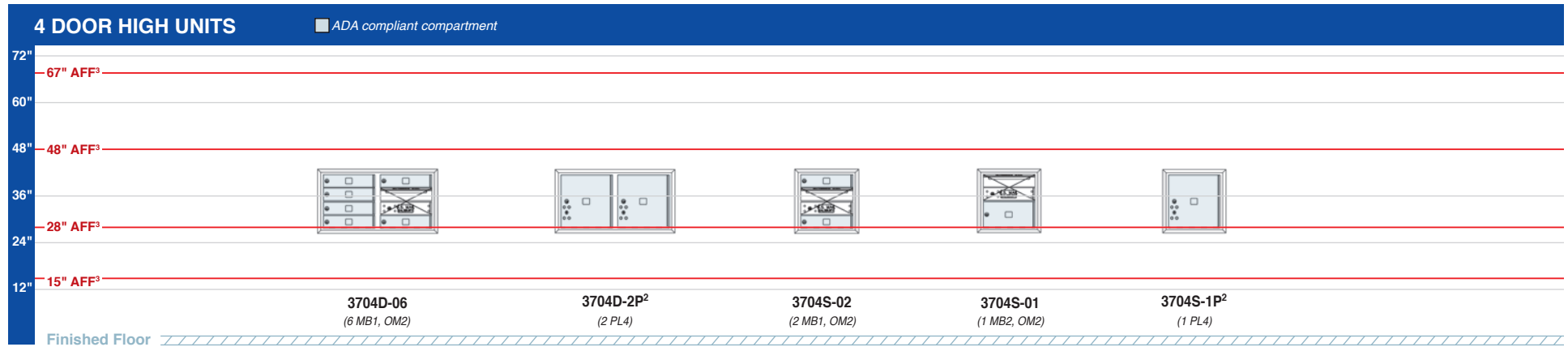
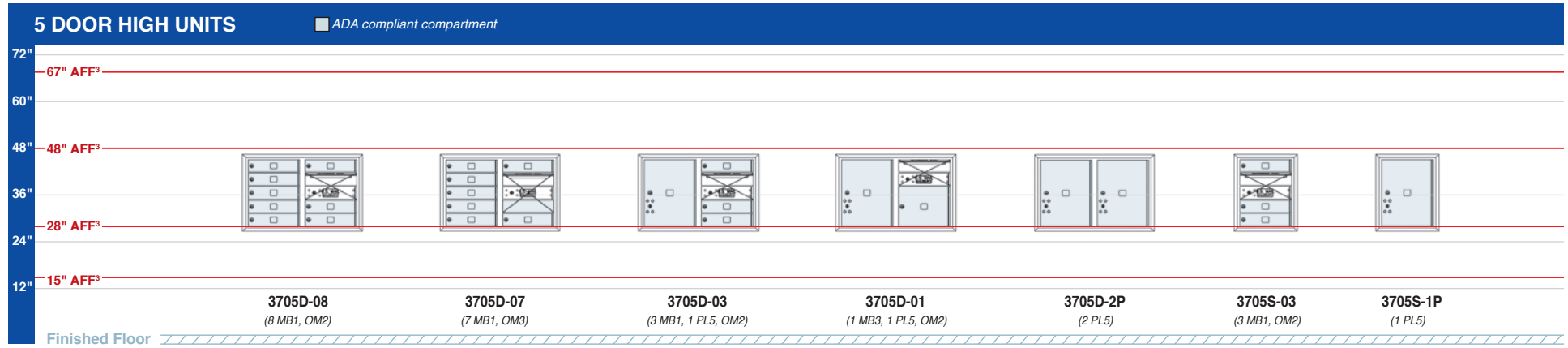

**SALSBUURY INDUSTRIES**  
People Committed to Quality Since 1936<sup>®</sup>

Salsbury Industries  
1010 East 62nd Street  
Los Angeles, CA 90001-1598  
Phone: (800) 624-5269  
Fax: (800) 624-5299  
email: [engineering@mailboxes.com](mailto:engineering@mailboxes.com)  
website: [www.mailboxes.com](http://www.mailboxes.com)

1 - Note: These units do not meet U.S.P.S. installation requirements and are for private delivery only unless approved by local postal authorities.

2 - For private delivery, unless parcel locker ratio exceeds requirement. U.S.P.S. standard 4C requires a minimum of one parcel locker for every ten (10) tenant compartments. Parcel lockers must be a minimum of 15" high (PL4.5, PL5 and PL6) to meet the 1:10 ratio. Once this ratio has been met, smaller parcel lockers (PL3 and PL4) may also be added.

3 - AFF=Above Finished Floor.

Copyright © 2015 Salsbury Industries. All rights reserved.